

PROFESSIONISTE IN UNIFORME CON A.I.D.I.A.

Progettazione di Hazardous Cargo Pad e
Combat Aircraft Parking Area per
rischieramento Forze NATO



Ten. G.A.r.n. CONVERTINI Maria
Capo Sezione Progettazione Interventi Speciali

INNOVAZIONE LOGISTICA OPERATIVA **DUEMILA 23**



Questo briefing è

NON CLASSIFICATO



INNOVAZIONE LOGISTICA OPERATIVA





AGENDA

- Scopo del lavoro
- Progettazione *Hazardous Cargo Pad*
- Progettazione *Combat Aircraft Parking Area*
- *Barricades*
- Quantity Distances e Net Explosive Quantity
- Criteri di posizionamento di *Hazardous Cargo Pad*
- Criteri di posizionamento di *C.A.P.A.*
- Conclusioni

SCOPO DEL LAVORO

- Riqualficazione raccordo Mike Alpha e Mike Bravo
- Realizzazione *Hazardous Cargo Pad* per velivoli STA
- Realizzazione *Combat Aircraft Parking Area* per velivoli TFA

«Implementare la partecipazione attiva del nostro Paese alle operazioni e alle attività congiunte con i Paesi membri attraverso il processo di standardizzazione delle infrastrutture a servizio della flotta aerea dell'Alleanza»



Taxiway Specifications:

Width of taxiway: 23 m

Taxiway Shoulder:

- 44 m where the code letter is F;
- 38 m where the code letter is E;
- 34 m where the code letter is D; and
- 25 m where the code letter is C.

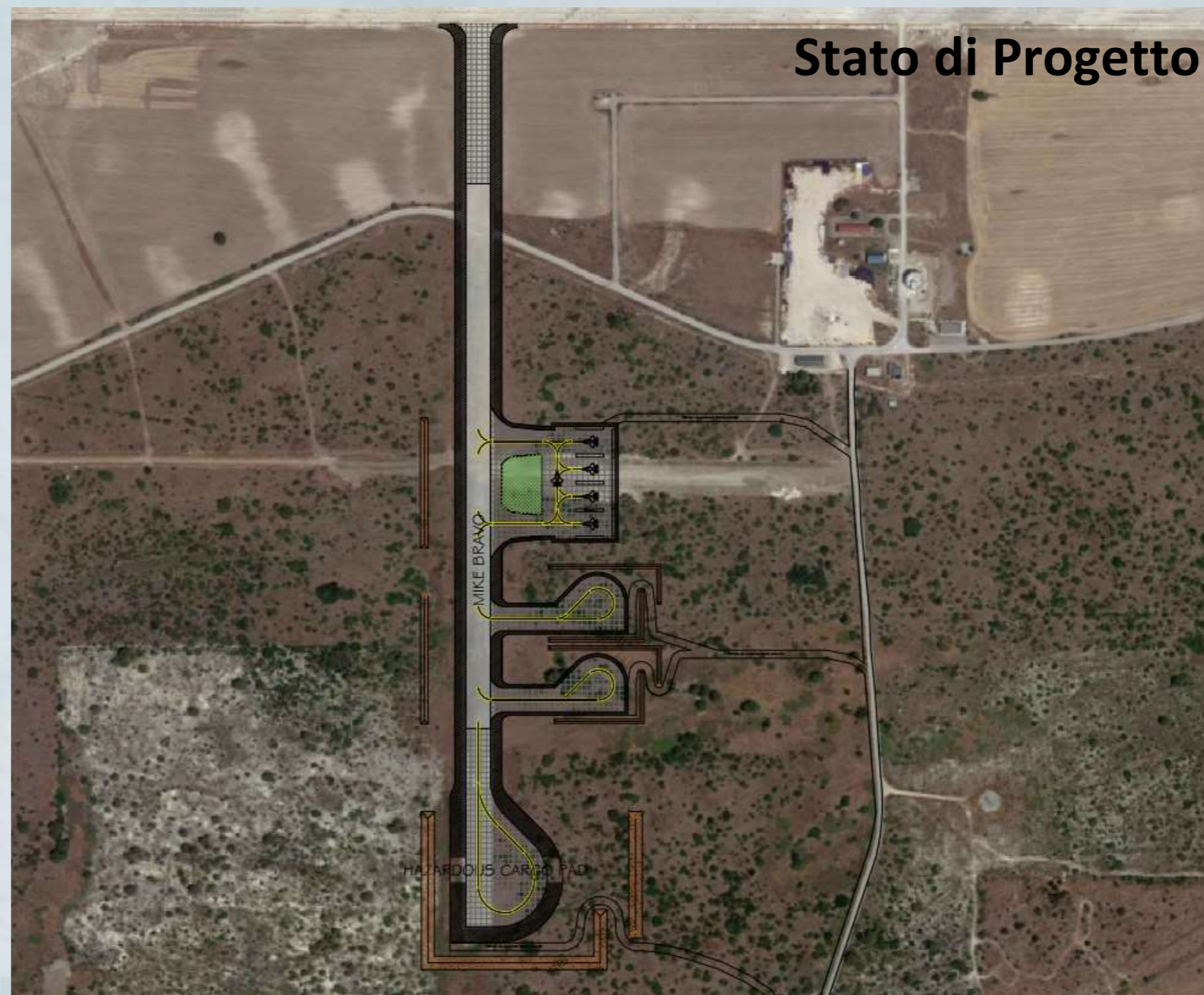

COMANDO LOGISTICO AM

Progettazione Hazardous Cargo Pad

- Scelte tecniche prese in ossequio alle disposizioni normative dettate dalla Direttiva NATO *Bi-SC 085-005*
- Aereo di progetto:

ITEM 4 - Aircraft Parking Platforms (Military Criteria)



Para. 3. Requirements – Note: d.

- Il velivolo STA di riferimento è il C-17;
- Il requisito minimo prevede di caricare/scaricare un velivolo STA alla volta, in condizioni di *under power*.



Dimensionamento *HCP*

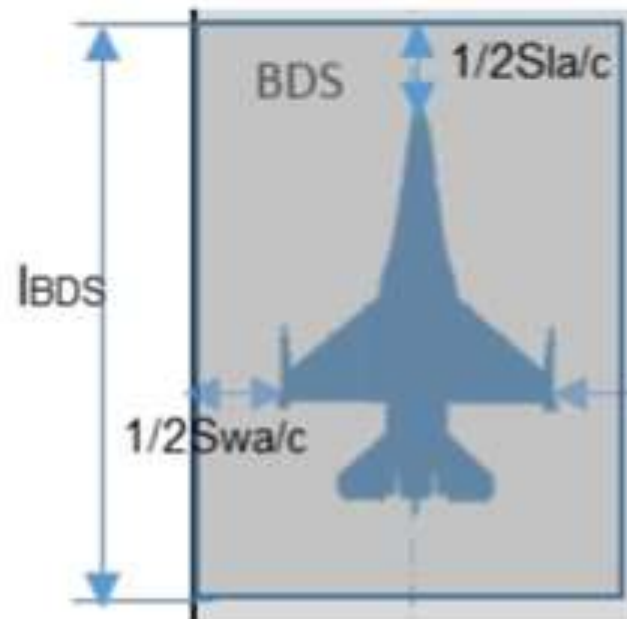

Dimensions of BDS are:

Length: $l_{BDS} = l_{a/c} + s_{la/c}$

Width: $W_{BDS} = w_{a/c} + s_{wa/c}$

Where,

W_{BDS} - BDS width

l_{BDS} - length of Bed Down Spot

$l_{a/c}$ - length of the aircraft;

$w_{a/c}$ - wingspan of the aircraft

$s_{wa/c}$; $s_{la/c}$ - clear space for aircraft handling

(find Aircraft Data Sheet in Annex B and clear space requirements for aircraft in Annex D)

$$l_{BDS} = l_{a/c} + s_{la/c} = 53,04 \text{ m} + s_{la/c}$$

$$W_{BDS} = w_{a/c} + s_{wa/c} = 51,76 \text{ m} + s_{wa/c}$$

	Parking (Item 4, Item 6)		In-Transit (Item 4)		Engine Testing (Item 6B)		Hangar (Item 19A)		Shelter (Item 19B)	
	Wing	Length	Wing	Length	Wing	Length	Wing	Length	Wing	Length
	[$s_{wa/c}$]	[$s_{la/c}$]	[$s_{wa/c}$]	[$s_{la/c}$]	[$s_{wa/c}$]	[$s_{la/c}$]	[$s_{wa/c}$]	[$s_{la/c}$]	[$s_{wa/c}$]	[$s_{la/c}$]
TFA	5 m	10 m	---	---	5 m	10 m	6 m	10 m	6 m	6 m
TTA	5 m	10 m	6 m	15 m			9 m	9 m	9 m	6 m
MPA			---	---						
AGS			---	---						
AAR ¹			---	---						
AEW			---	---						
STA ⁺			12 m	25 m						
STA ²			12 m	25 m						
SBA			---	---						
RWA	FATO+ 3 m	FATO+ 3 m	---	---	6 m	6 m	6 m	6 m		

¹ For KC-10, KC-46 and KC-135 consider the wingtip clearance of 15.3m

² For C-5 and C-17 consider the wingtip clearance of 7.7m



Dimensionamento HCP

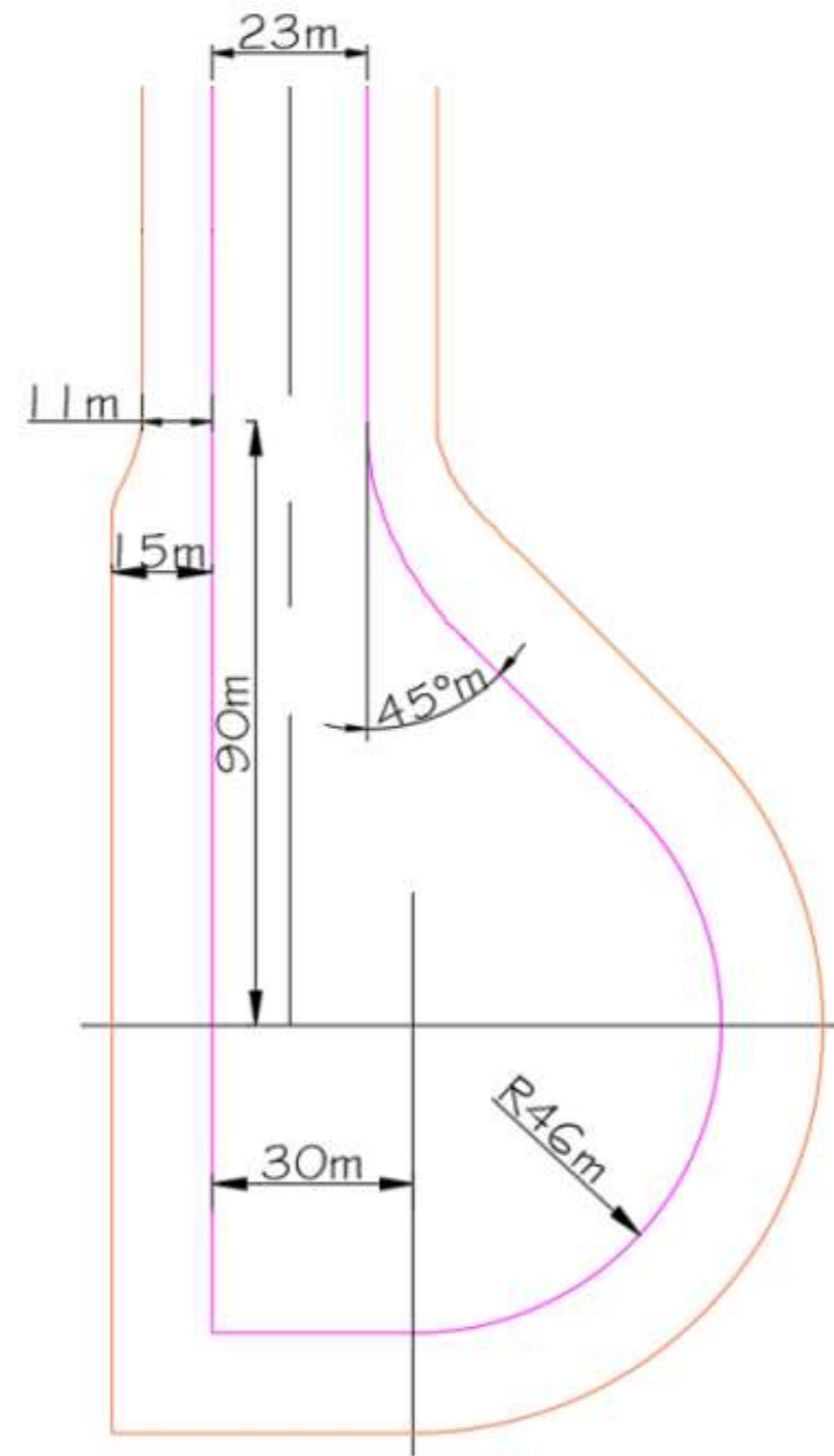
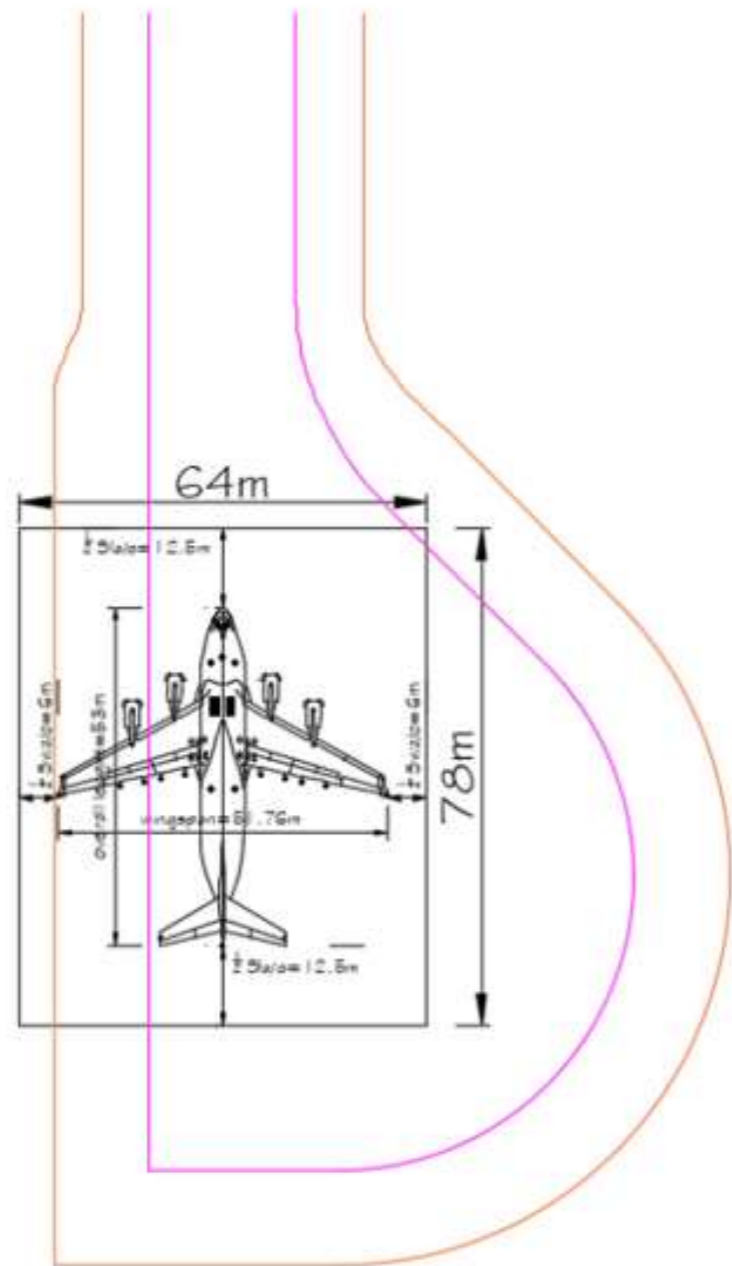

Progettazione *Combat Aircraft Parking Area*

Area pavimentata destinata esclusivamente allo stazionamento di aerei armati che abbiano accesso immediato e senza impedimenti alla pista.



Progettazione C.A.P.A.

Disposte lungo lo sviluppo longitudinale del raccordo Mike Bravo.

Scenari sviluppati:

- n. 2 C.A.P.A. stanziali – l'aereo esegue le operazioni di taxi-in e taxi-out in autonomia;
- n. 4 C.A.P.A. da rischieramento – il velivolo è posizionato nello *spot* di attesa mediante il push-back di mezzi da traino.

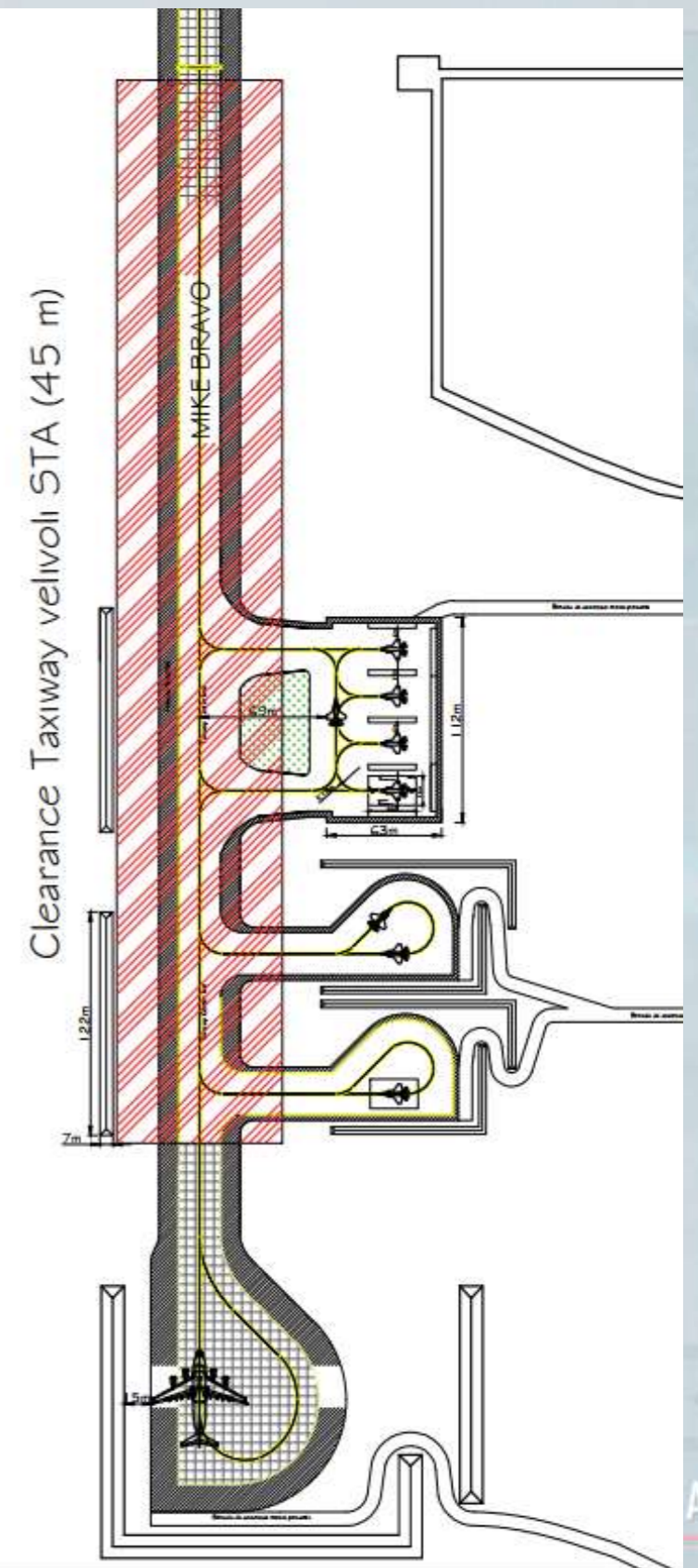

Progettazione C.A.P.A.

Aereo di progetto



$$l_{BDS} = l_{a/c} + s_{la/c} = 16 \text{ m} + 10 \text{ m} = 26 \text{ m}$$

$$w_{BDS} = w_{a/c} + s_{wa/c} = 11 \text{ m} + 5 \text{ m} = 16 \text{ m}$$

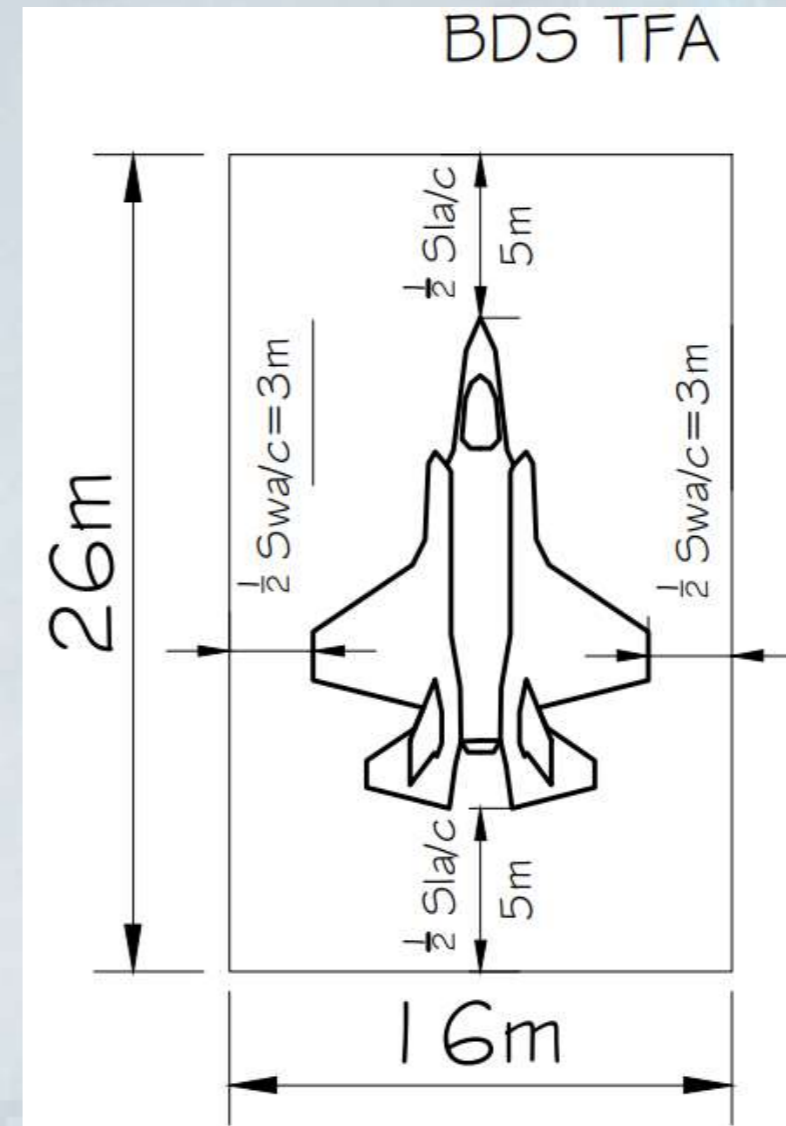

C.A.P.A. stanziali

- Turn back in self-manouvering;
- Ottimizzazione tempi di reazione.

Questa soluzione è ottimale se si considera che le forze aeree operano in guerra dalle stesse località che occupano in tempo di pace.

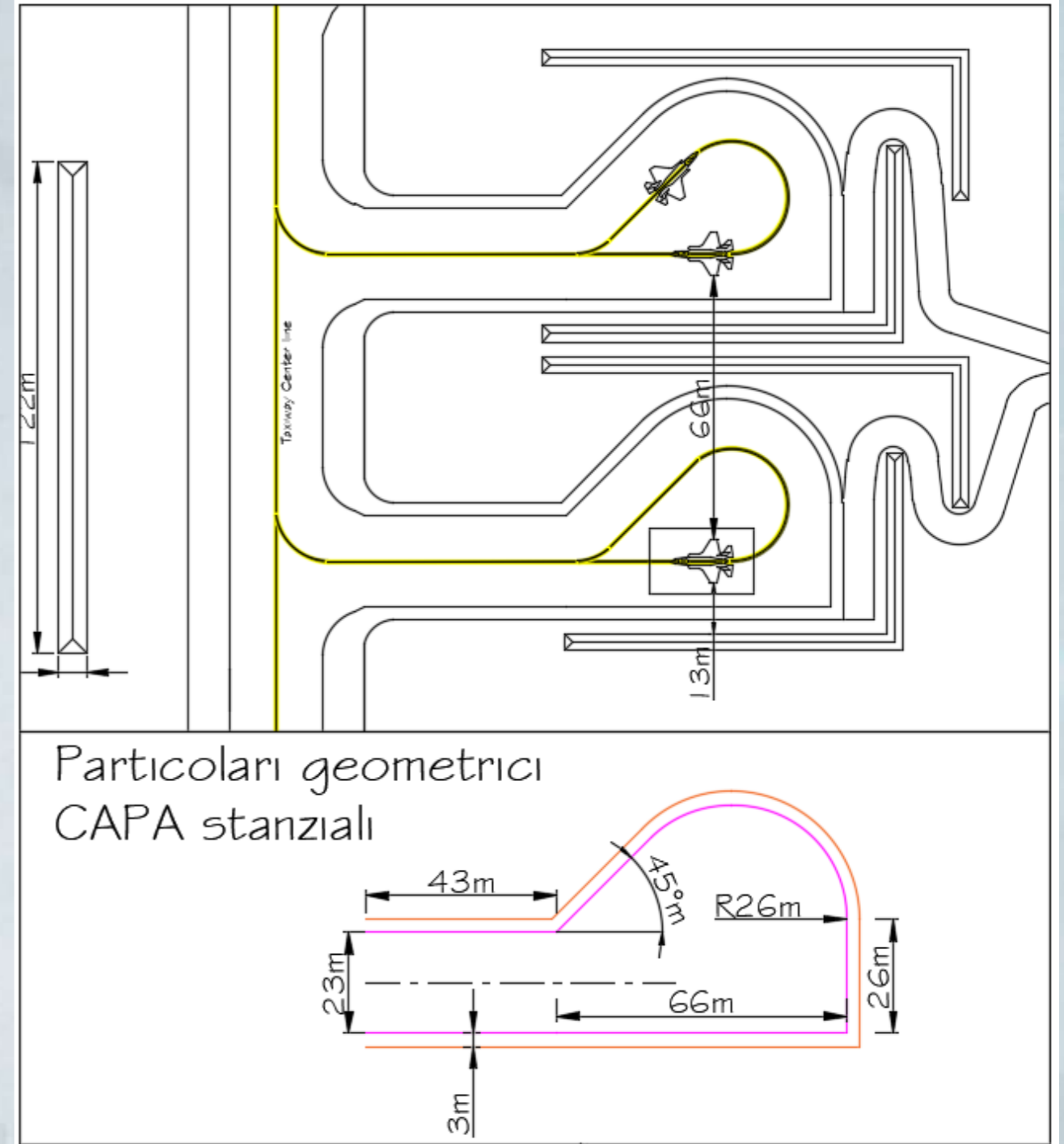

C.A.P.A. da rischieramento

- Towed Parking;
- Massimo numero di *alert aircraft* a parità di superficie pavimentata in cls;

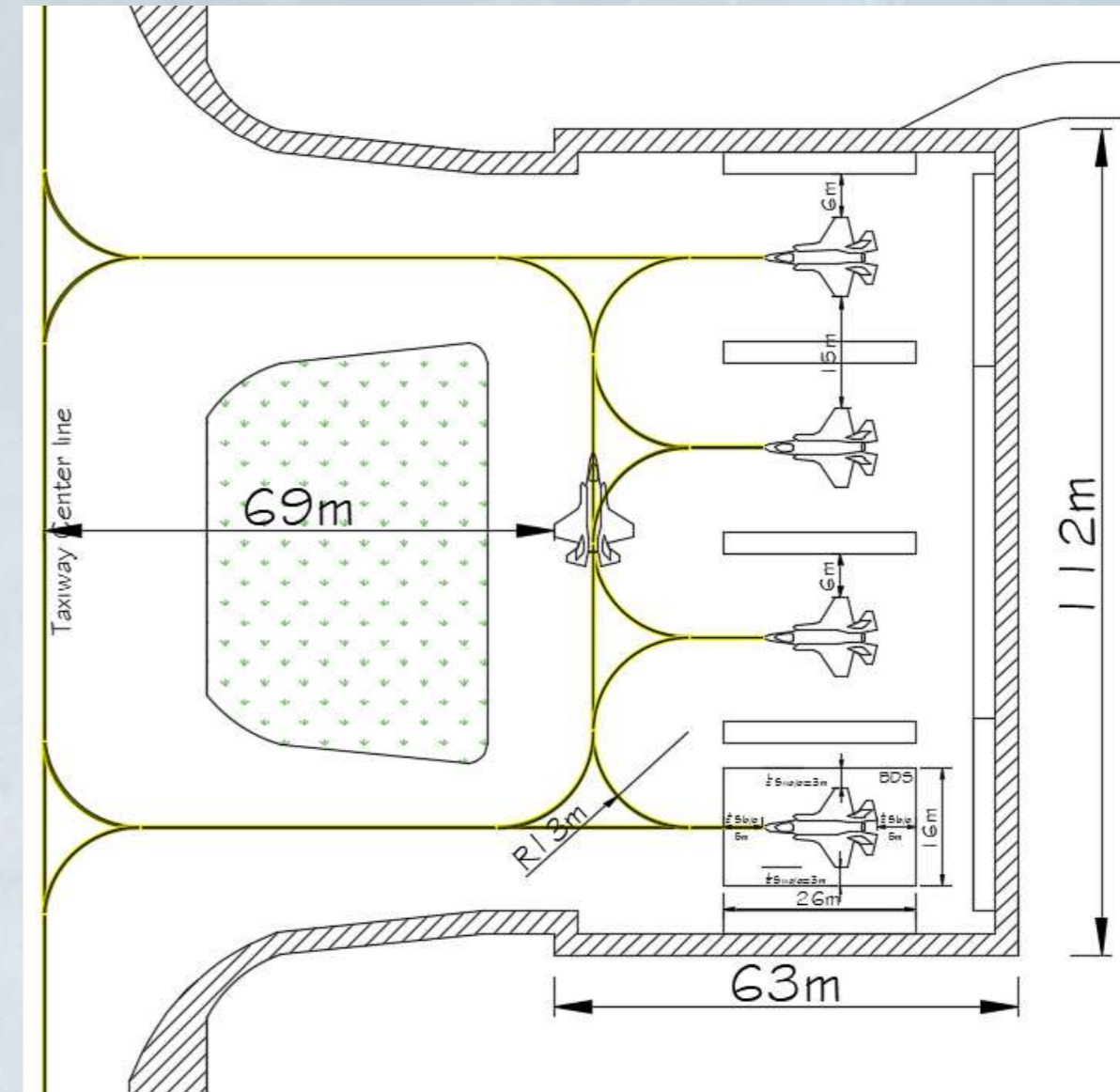

BARRICADES

Lo scopo ultimo è quello di intercettare le proiezioni ad alta velocità e a basso angolo provenienti da un *Potential Explosion Site* (PES) così da impedire la propagazione istantanea dell'esplosione ad un *Exposed Site* (ES).



BARRICADES - Caratteristiche geometriche

- Altezza – linea AB

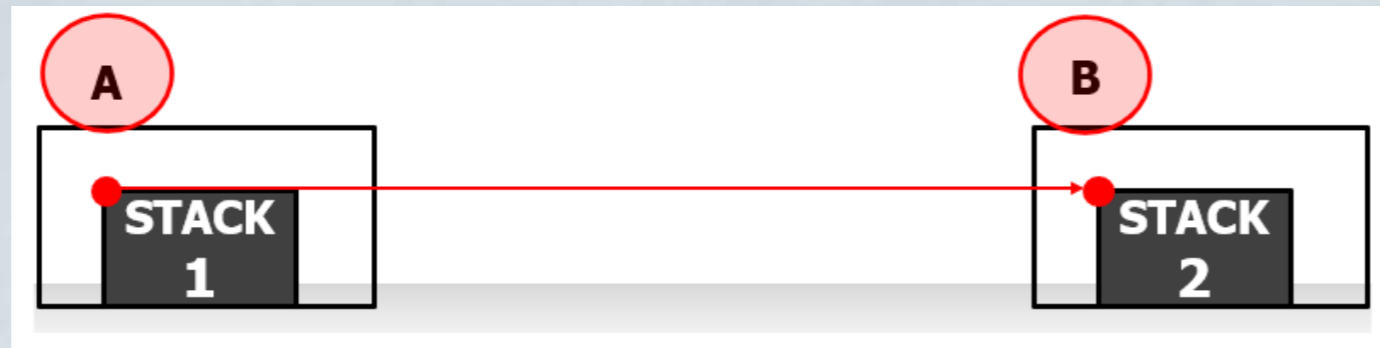

Terreno pianeggiante
Stacks di stessa altezza



Terreno in pendenza
Stacks di diversa altezza



BARRICADES - Caratteristiche geometriche

- Altezza – linea AC con angolo di 2° al di sopra della linea AB

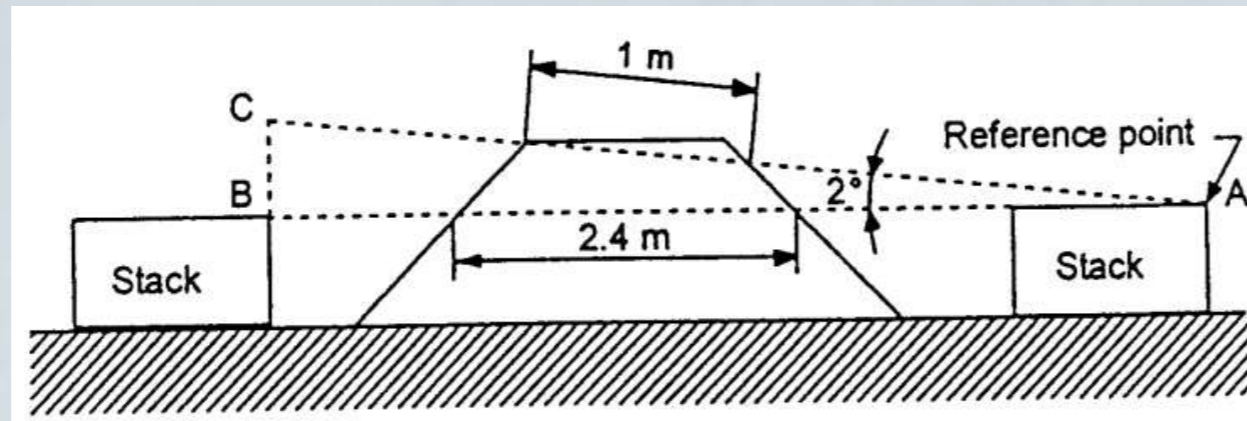

Terreno pianeggiante
Stacks di stessa altezza

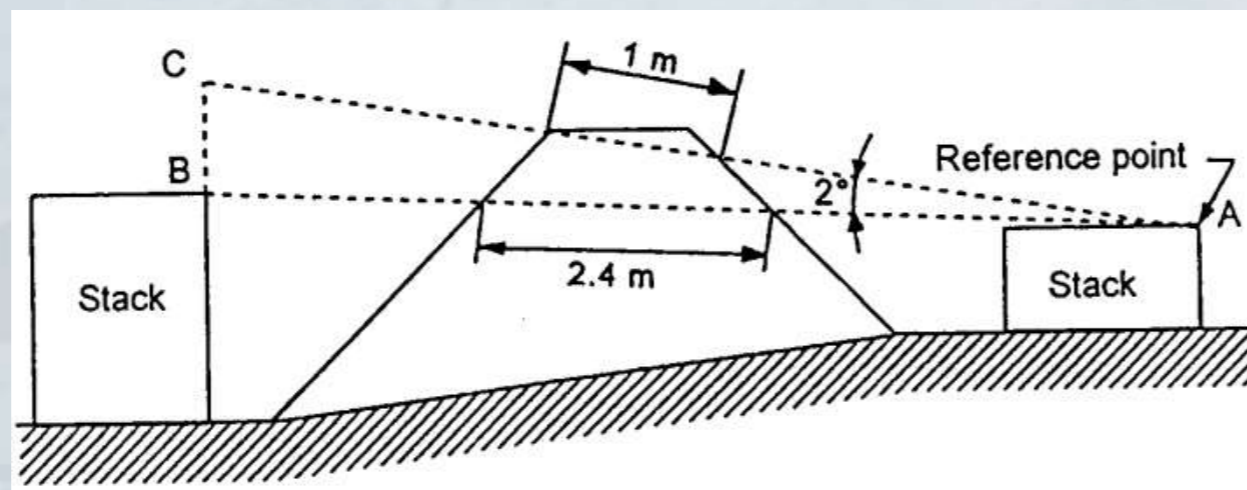

Terreno in pendenza
Stacks di diversa altezza



- Lunghezza

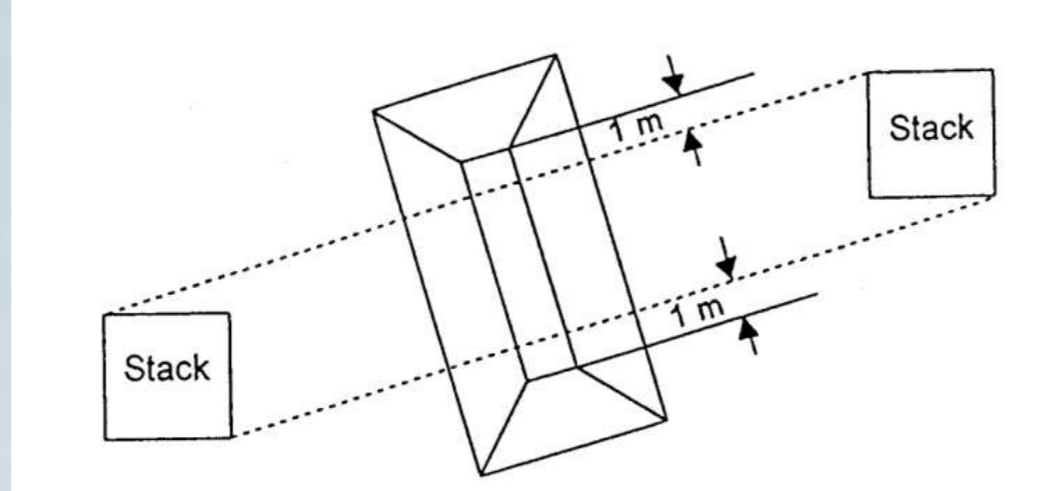

Si estende in lunghezza per 1 metro oltre le estremità della catasta di esplosivi

- Distanza tra *stack* e base della *barricade*

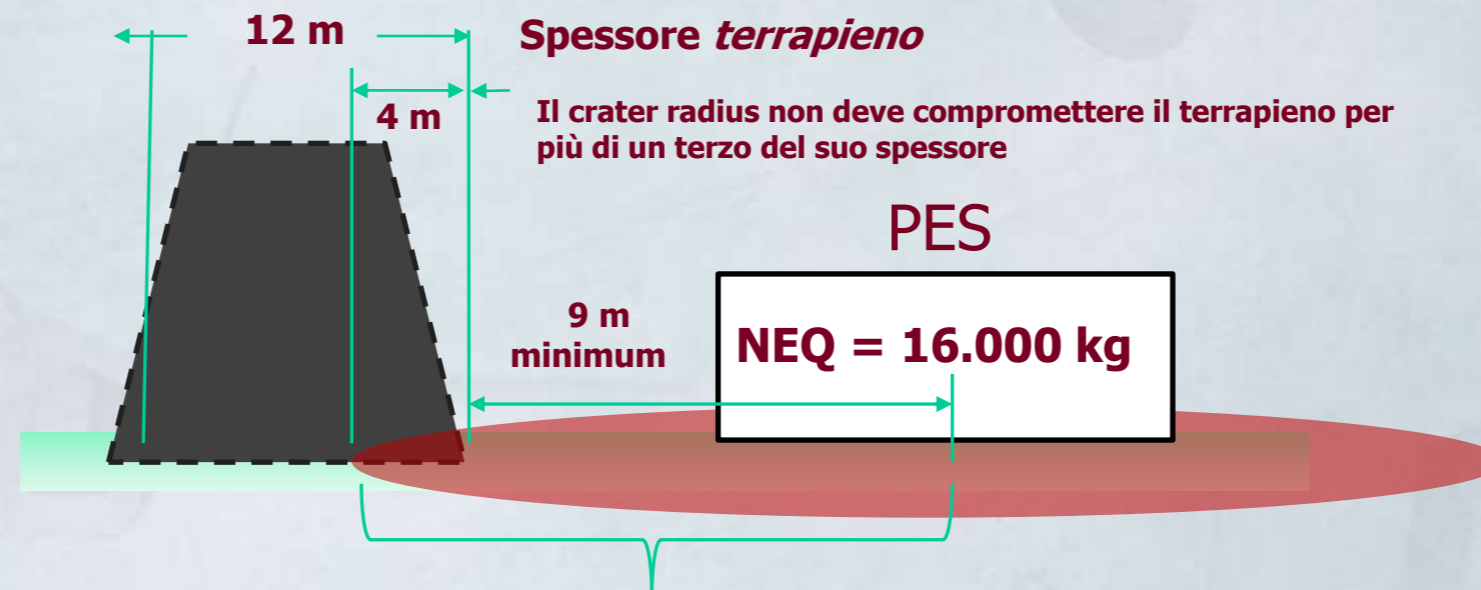

Radius (m) = $0.5(NEQ)^{1/3} = 0.5(16.000)^{1/3} = 12,59$ m;
round up to 13 m



BARRICADES – *Hazardous Cargo Pad*

- *Crater radius*

$$0.5 \sqrt[3]{NEQ} = 0.5 \cdot \sqrt[3]{15.000} =$$
$$0.5 \cdot 24.66 = 13 \text{ m}$$

- *Apron clearance*

15 m – Item 4 - Aircraft Parking
Platforms, para 2.d.(1)

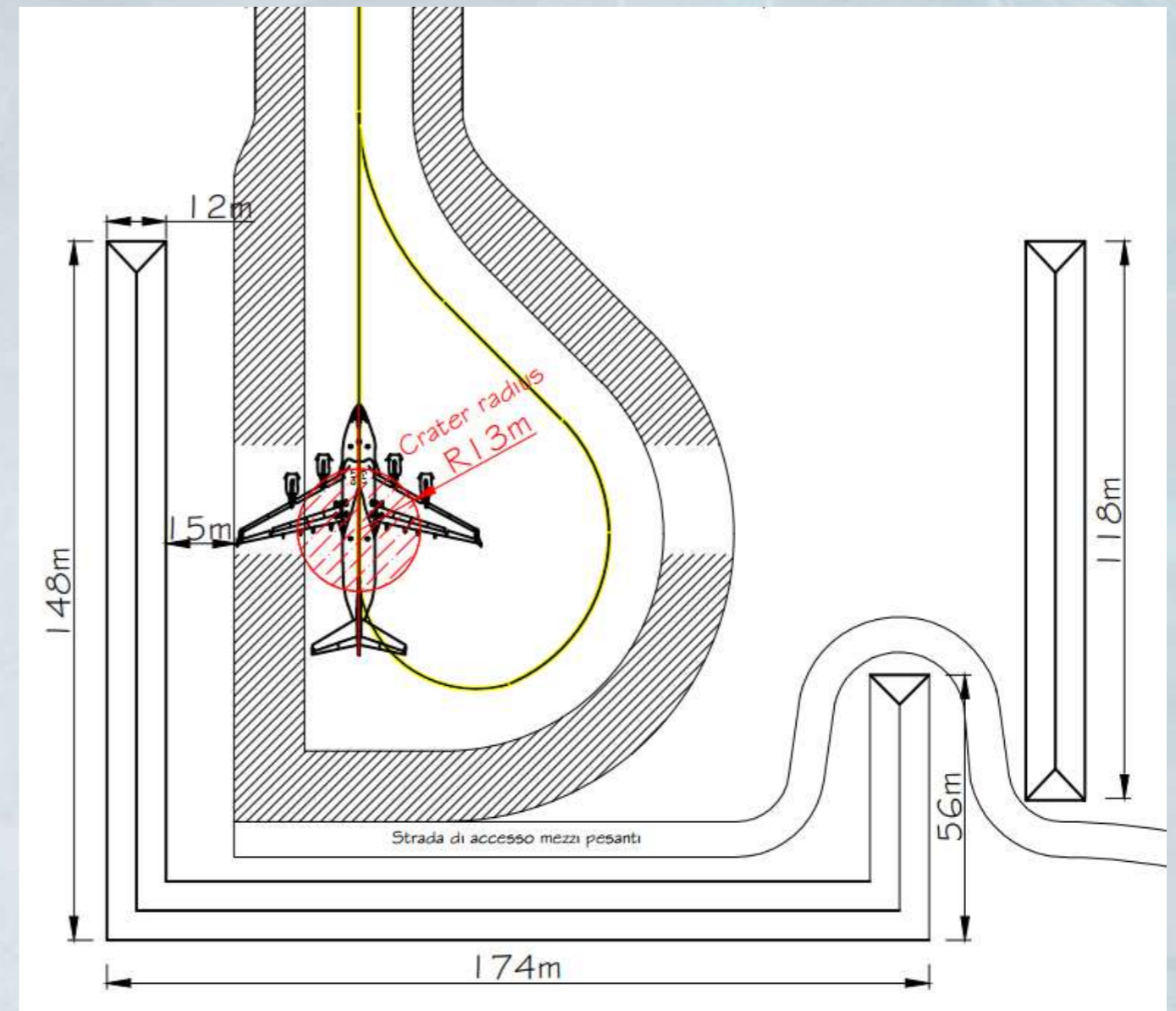

BARRICADES – *Hazardous Cargo Pad*

- *Crater radius*

$$0.5\sqrt[3]{NEQ} = 0.5\sqrt[3]{250.000} =$$
$$0.5 \cdot 63 = 32 \text{ m}$$

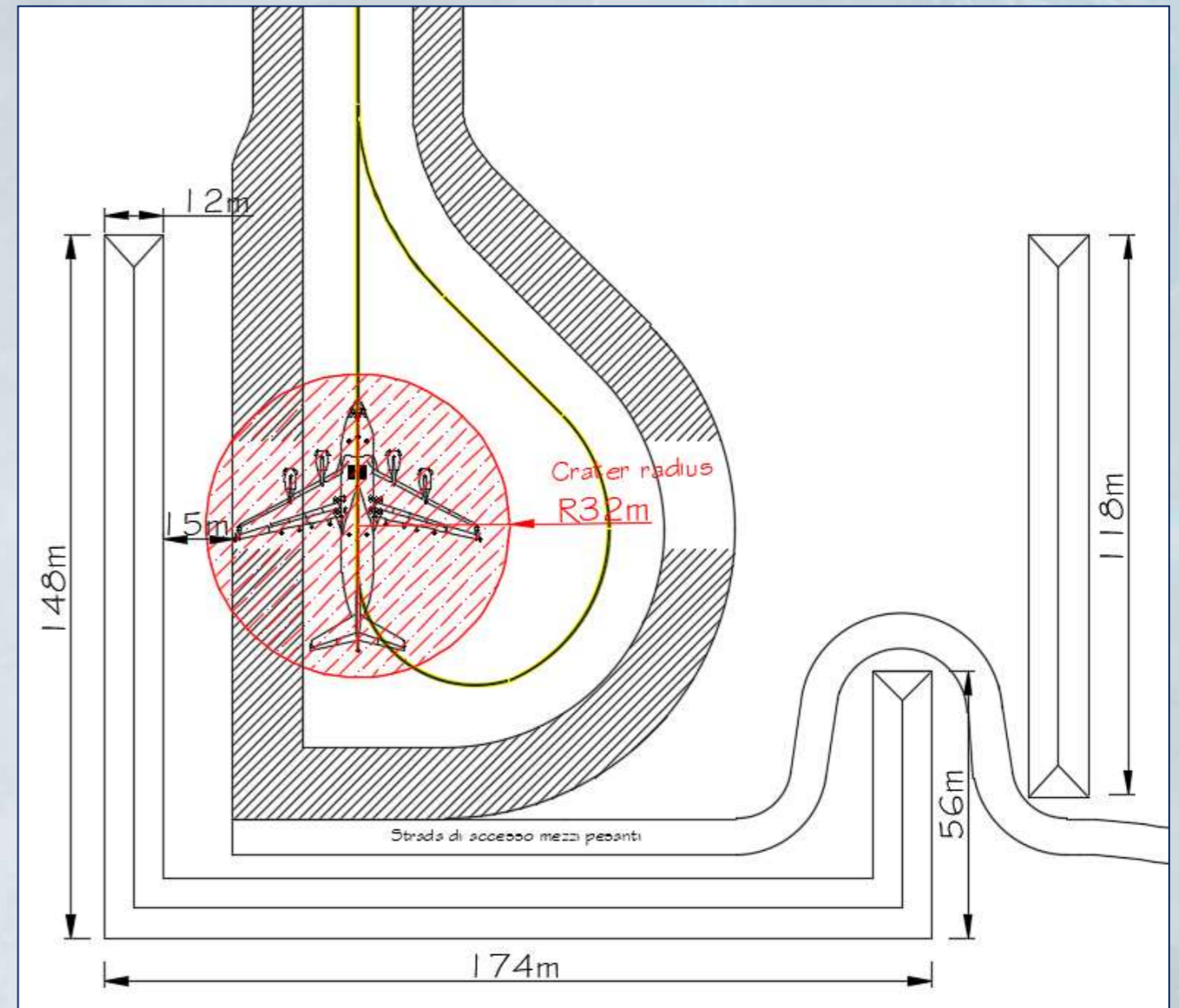

BARRICADES – *Combat Aircraft Parking Area*

- *Crater radius*

Aria – aria

$$0.5^3 \sqrt{NEQ} = 0.5^3 \sqrt{500} =$$
$$0.5 \cdot 7,94 = 4 \text{ m}$$

Aria – suolo

$$0.5^3 \sqrt{NEQ} = 0.5^3 \sqrt{2.000} =$$
$$0.5 \cdot 12.6 = 7 \text{ m}$$

- *Apron clearance*

6 m – Item 4 – Aircraft Parking

Platforms, para 2.d.(1)

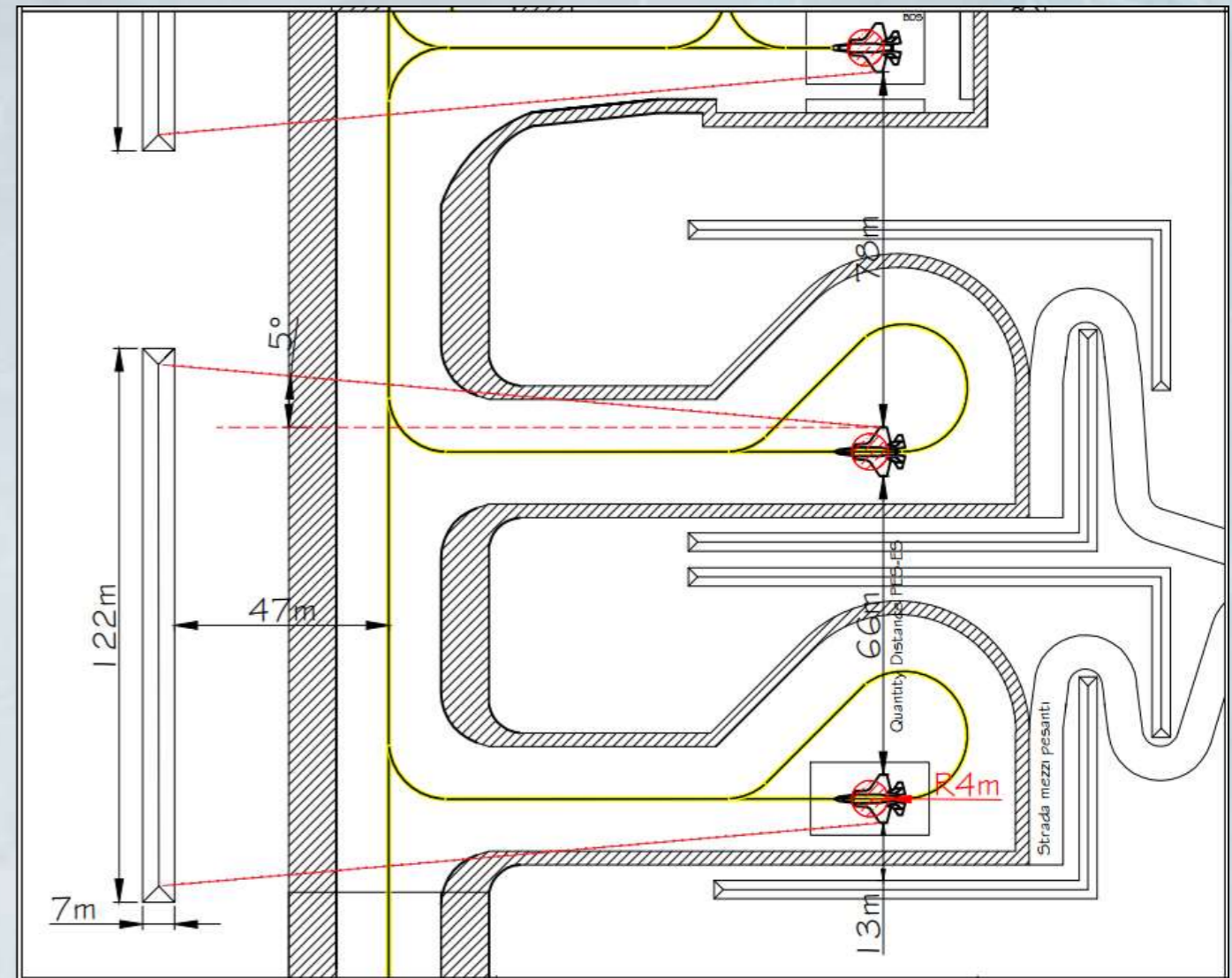

Quantity Distances e Net Explosive Quantity

- Quantity Distances (QD): distanze tra *Potential Explosion Site* (PES) - come edifici e mezzi - ed *Exposed Site* (ES) tali da ridurre al minimo il rischio per la salvaguardia della vita.
- Net Explosive Quantity (NEQ): massimo quantitativo di materiale esplosivo che può essere stoccato in un PES (in TNT).

QD Tables

Si sviluppano in due fasi:

1. Intersezione pittogrammi PES – ES ed individuazione di “D”;
2. Tabella NEQ (kg) e distanza di separazione.











Criteri di posizionamento di *Hazardous*

Cargo Pad

QD tra Hazardous Cargo Pad e C.A.P.A.

- Si applica il manuale AASTP1;
- Si individua il pittogramma che meglio descrive il PES;
- Tra i 28 tipi di Exposed Site si individua quello di interesse considerando le caratteristiche costruttive e la destinazione d'uso dell'ES

Table 1C HD 1.1 QD Matrix for Non-Earth Covered Storage

PES ES	 (a)	 (b)	 (c)	 (d)
	Building constructed with walls of 215 mm brick (or equivalent) and protective roof of 150 mm concrete with suitable support, barricaded. Process Facility, barricaded.	Building constructed with walls of 215 mm brick (or equivalent) and protective roof of 150 mm concrete with suitable support, unbaricaded. Process Facility, unbaricaded.	Open-air stack or light structure, barricaded. Truck, trailer, rail-car or freight container loaded with ammunition, barricaded.	Open-air stack or light structure, unbaricaded. Truck, trailer, rail-car or freight container loaded with ammunition, unbaricaded.
 1 Standard NATO Igloo, designed for 7 bar in accordance with Part 2, with the door facing away from PES	D5 Virtually complete protection	D5 Virtually complete protection	D5 Virtually complete protection	D5 Virtually complete protection
 2 Standard NATO Igloo, designed for 7 bar in accordance with Part 2, with the door facing perpendicularly to the direction of PES	D5 High degree of protection	D5 High degree of protection	D5 High degree of protection	D5 High degree of protection
 3 Standard NATO Igloo, designed for 7 bar in accordance with Part 2, with the door towards a PES	D8 High degree of protection 1.3.5.6 1b Effect of lobbed ammunition	D8 High degree of protection 1.3.5.6 1b Effect of lobbed ammunition	D8 High degree of protection 1.3.5.6 1b Effect of lobbed ammunition	D8 High degree of protection 1.3.5.6 1b Effect of lobbed ammunition
 4 Igloo designed for 3 bar in accordance with Part 2.	D5 High degree of protection	D5 High degree of protection	D5 High degree of protection	D5 High degree of protection



Criteria di posizionamento di *Hazardous*



Cargo Pad

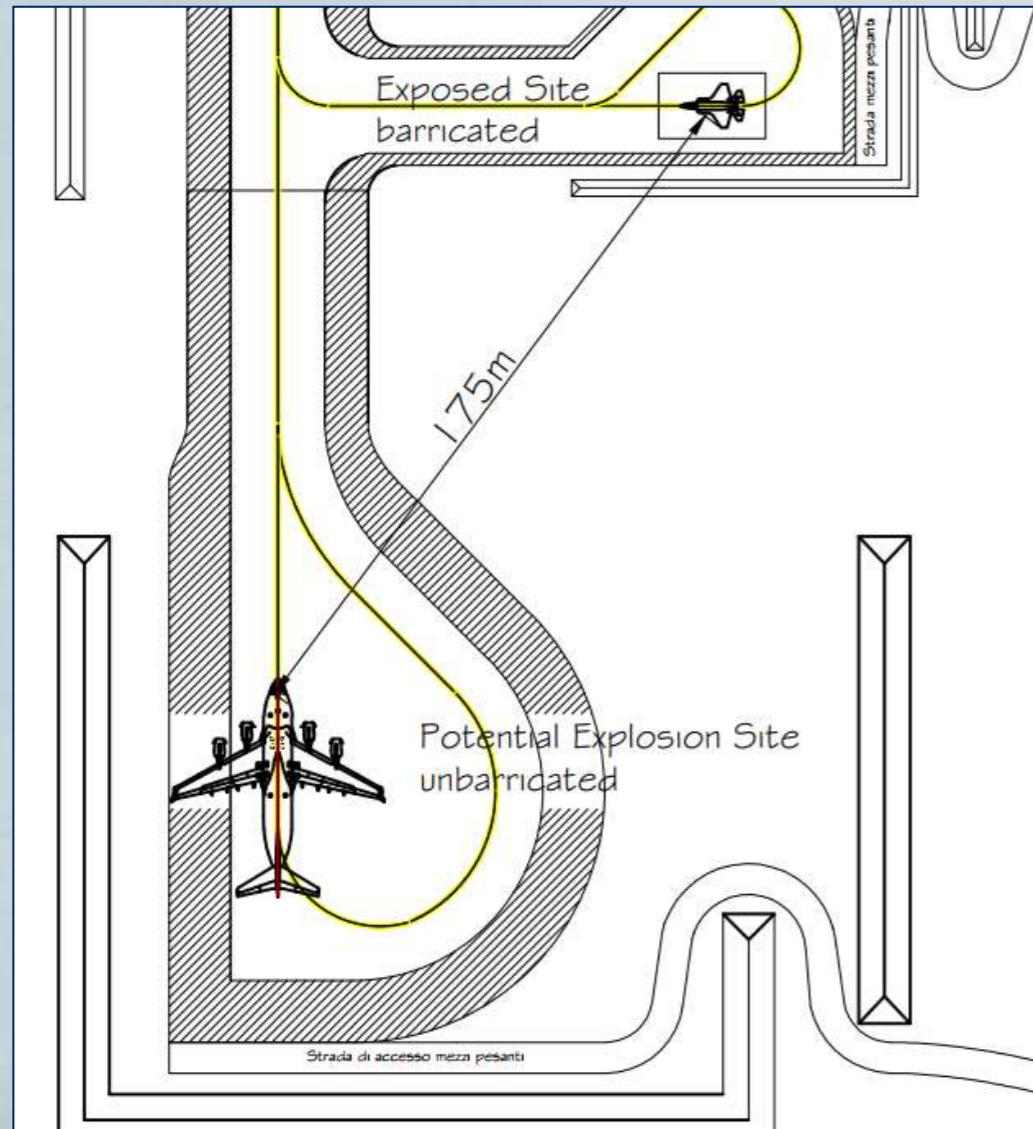

Table 1C HD 1.1 QD Matrix for Non-Earth Covered Storage

PES ES	(a)	(b)	(c)	(d)
<p>Building constructed with walls of 215 mm brick (or equivalent) and protective roof of 150 mm concrete with suitable support, barricaded. Process Facility, barricaded</p>	<p>Building constructed with walls of 215 mm brick (or equivalent) and protective roof of 150 mm concrete with suitable support, unbarricaded. Process Facility, unbarricaded</p>	<p>Open-air stack or light structure, barricaded. Truck, trailer, rail-car or freight container loaded with ammunition, barricaded.</p>	<p>Open-air stack or light structure, unbarricaded. Truck, trailer, rail-car or freight container loaded with ammunition, unbarricaded.</p>	
<p>16 Open air stack or light structure, barricaded. Truck, trailer, rail-car or freight container loaded with ammunition, barricaded.</p>	<p>D4</p> <p>High degree of protection 1.3.3.5 No primary explosives 1.3.5.3 No items vulnerable to spall 1.3.5.6 1b Effect of lobbed ammunition</p> <p>or D7</p> <p>High degree of protection 1.3.5.6 1b Effect of lobbed ammunition</p>	<p>D4</p> <p>High degree of protection 1.3.3.5 No primary explosives 1.3.5.3 No items vulnerable to spall 1.3.5.6 1b Effect of lobbed ammunition</p> <p>or D7</p> <p>High degree of protection 1.3.5.6 1b Effect of lobbed ammunition</p>	<p>D4</p> <p>High degree of protection 1.3.3.5 No primary explosives 1.3.5.3 No items vulnerable to spall 1.3.5.6 1b Effect of lobbed ammunition</p> <p>or D7</p> <p>High degree of protection 1.3.5.6 1b Effect of lobbed ammunition</p>	<p>D4</p> <p>High degree of protection 1.3.3.5 No primary explosives 1.3.5.3 No items vulnerable to spall 1.3.5.6 1b Effect of lobbed ammunition</p> <p>or D7</p> <p>High degree of protection 1.3.5.6 1b Effect of lobbed ammunition</p>
	<p>ammunition</p>	<p>ammunition</p>	<p>ammunition</p> <p>D1 or D2</p> <p>High degree of protection 1.3.3.1 Open bomb bay storage 1.3.5.6 1b Effect of lobbed ammunition</p>	<p>ammunition</p> <p>D1 or D2</p> <p>High degree of protection 1.3.3.1 Open bomb bay storage 1.3.5.6 1b Effect of lobbed ammunition</p>







TABLE 1D QUANTITY DISTANCES FOR HAZARD DIVISION 1.1

NEQ (kg)	Quantity- Distances (m)												
	D1	D2	D3	D4	D5	D6	D7	D8	D9	D10	D11	D12	D13
500	3		5	7	9	15	20	29	39	64	180	180	270
600	3		5	7	10	16	21	31	41	68	180	190	270
700	4		5	8	10	16	22	32	43	72	180	200	270
800	4		5	8	11	17	23	34	45	75	180	210	270
900	4		5	8	11	18	24	35	47	78	180	215	270
1 000	4		5	8	11	18	24	36	48	80	180	225	270
1 200	4		6	9	12	20	26	39	52	86	180	240	270
1 400	4		6	9	13	21	27	41	54	90	180	250	270
1 600	5		6	10	13	22	29	43	57	94	180	260	270
1 800	5		7	10	14	22	30	44	59	98	180	270	270
2 000	5		7	11	14	23	31	46	61	105	180	280	270
2 500	5		7	11	15	25	33	49	66	110	185	305	280
3 000	6		8	12	16	26	35	52	70	120	205	325	305
3 500	6		8	13	17	28	37	55	73	125	220	340	330
4 000	6		8	13	18	29	39	58	77	130	235	355	350
5 000	6		9	14	19	31	42	62	83	140	255	380	380
6 000	7		10	15	20	33	44	66	88	150	270	405	405
7 000	7		10	16	22	35	46	69	92	155	285	425	425
8 000	7		10	16	22	36	48	72	96	160	300	445	445
9 000	8		11	17	23	38	50	75	100	170	310	465	465
10 000	8		11	18	24	39	52	78	105	175	320	480	480
12 000	9		12	19	26	42	55	83	110	185	340	510	510
14 000	9		13	20	27	44	58	87	120	195	360	540	540
16 000	10		14	21	29	48	61	91	125	205	375	560	560
18 000	10		14	21	29	48	63	95	130	210	390	590	590
20 000	10		14	22	30	49	66	98	135	220	405	610	610
25 000	11		15	24	33	53	71	110	145	235	435	650	650
30 000	11		16	25	35	56	75	115	150	250	460	690	690
35 000		15	17	27	36	59	79	120	160	265	485	730	730
40 000		16	18	28	38	62	83	125	165	275	510	760	760



Inhabited Building Distance - HCP

Table 1C HD 1.1 QD Matrix for Non-Earth Covered Storage

PES  ES 	 Building constructed with walls of 215 mm brick (or equivalent) and protective roof of 150 mm concrete with suitable support, barricaded. Process Facility, barricaded. (a)	 Building constructed with walls of 215 mm brick (or equivalent) and protective roof of 150 mm concrete with suitable support, unbarricaded. Process Facility, unbarricaded. (b)	 Open-air stack or light structure, barricaded. Truck, trailer, rail-car or freight container loaded with ammunition, barricaded. (c)	 Open-air stack or light structure, unbarricaded. Truck, trailer, rail-car or freight container loaded with ammunition, unbarricaded. (d)
21 Low Density Usage Roads - Less than 1000 vehicles per day Railways - Less than 1000 passengers per day Waterways - Less than 400 users per day Public Rights of Way or Recreational Facilities - Less than 200 users per day (See 1.3.1.14 for full definitions)	0.5 x D12 No QD for Very Low Density Usage Roads and Public Rights of Way	0.5 x D12 No QD for Very Low Density Usage Roads and Public Rights of Way	0.5 x D12 No QD for Very Low Density Usage Roads and Public Rights of Way	0.5 x D12 No QD for Very Low Density Usage Roads and Public Rights of Way
22 Medium Density Usage Roads - 1000 or more but less than 5000 vehicles per day Railways - 1000 or more but less than 5000 passengers per day Waterways - 400 or more but less than 1800 users per day Public Rights of Way or Recreational Facilities - 200 or more but less than 900 users per day (See 1.3.1.14 for full definitions)	D11 (≥270m)	D11 (≥270m)	D11	D11
23 High Density Usage Roads - 5000 or more vehicles per day Railways - 5000 or more passengers per day Waterways - 1800 or more users per day Public Rights of Way or Recreational Facilities - 900 or more users per day (See 1.3.1.14 for full definitions)	D13 (≥400m)	D13 (≥400m)	D13	D13
 24 Inhabited Building Places of Assembly	D12 (≥270m) 1.3.1.15 2.b D13 (≥400m)	D13 (≥400m)	D12 (≥270m) 1.3.1.15 2.b or D13 (≥400m)	D13 (≥400m)
25 Vulnerable Constructions (1.3.1.15 for full definition)	2 x D12	2 x D12	2 x D12	2 x D12

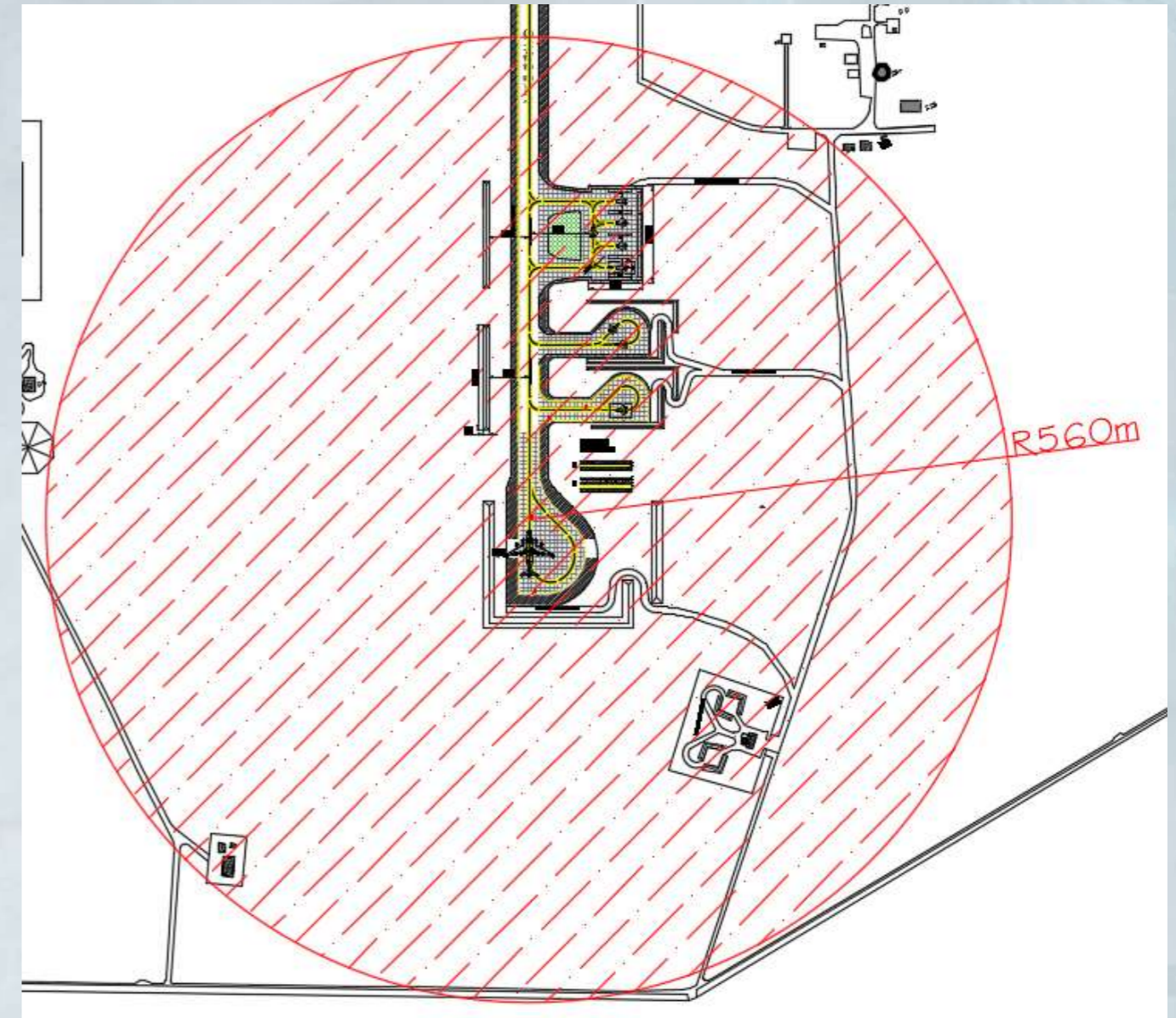

Criteri di posizionamento di *Combat Aircraft*

Parking Area

QD tra C.A.P.A. stanziali

Il manuale AASTP1, Part IV – Chapter 5 “Airfields Used Only By Military Aircraft” al paragrafo 4.5.1.4. prescrive che:

- aeromobili non barricati o gruppi di aeromobili carichi di esplosivi siano separati l'uno dall'altro da distanze $AD13 (12 Q^{1/3})$;
- sia prevista una distanza di 270 m per una protezione completa contro i frammenti;
- singoli o gruppi di aeromobili siano separati da distanze $AD10 (7.2 Q^{1/3})$; per proteggersi dalla propagazione della detonazione.



Criteri di posizionamento di *Combat Aircraft*

Parkina Area

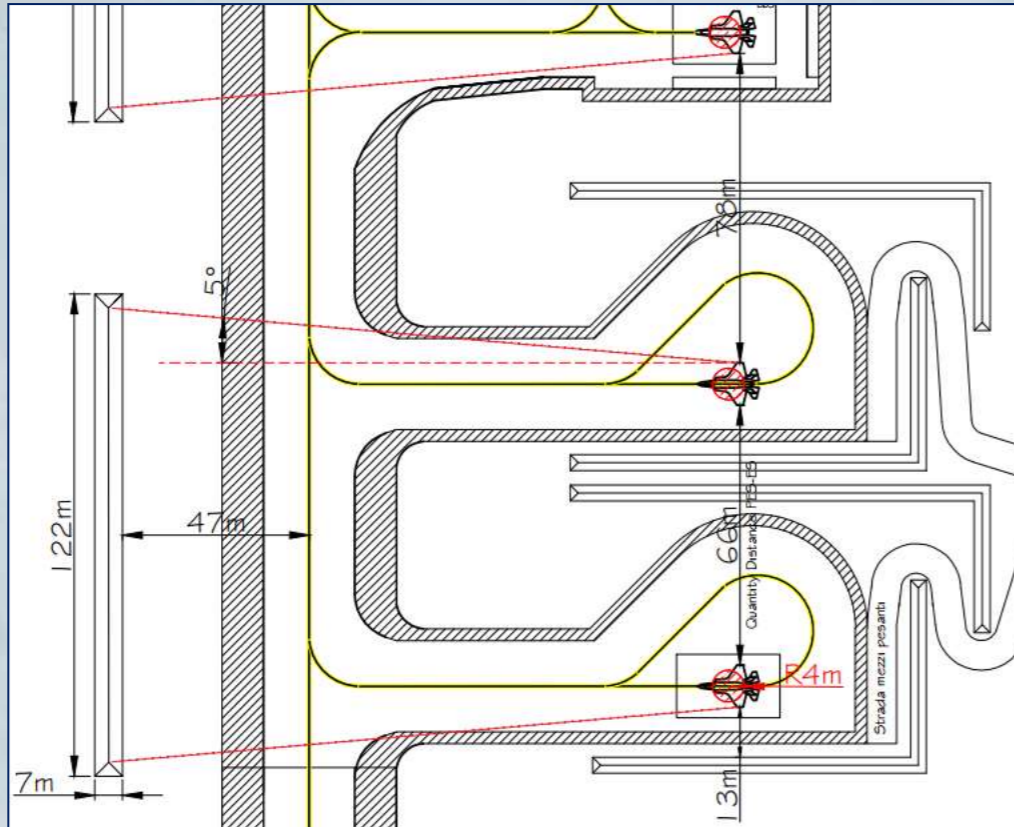

NEQ (kg)	QD (m)									
	AD1	AD2	AD3	AD4	AD5	AD6	AD7	AD8	AD9	AD10
500										58
600	5	7	10	16	17	21	27	31	38	61
700	5	7	10	16	18	22	28	32	40	64
800	5	7	11	17	19	23	30	34	41	67
900	5	8	11	18	19	24	31	35	43	70
1 000	5	8	11	18	20	24	32	36	44	72
1 200	6	9	12	20	21	26	34	39	47	77
1 400	6	9	13	21	22	27	36	41	50	81
1 600	6	9	13	22	23	29	37	43	52	85
1 800	7	10	14	22	24	30	39	44	54	88
2 000	7	10	14	23	25	31	40	46	56	91
2 200	7	10	14	24	26	31	42	47	57	94
2 500	7	11	15	25	27	33	43	49	60	98
3 000	8	12	16	26	29	35	46	52	64	105
3 500	8	12	17	28	30	37	49	55	67	110
4 000	8	13	18	29	32	39	51	58	70	115
4 400	8	13	18	30	33	39	52	59	72	120
5 000	9	14	19	31	34	42	55	62	76	125
6 000	10	15	20	33	36	44	58	66	80	135
7 000	10	15	22	35	38	46	61	69	85	140
8 000	10	16	22	36	40	48	64	72	88	145
8 800	10	17	23	37	41	50	66	74	91	150
9 000	11	17	23	38	42	50	67	75	92	150
10 000	11	17	24	39	43	52	69	78	95	160



Criteri di posizionamento di *Combat Aircraft*

Parking Area

QD tra C.A.P.A. da rischieramento

Si applicando le prescrizioni del manuale AASTP5 “NATO Guidelines for the Storage, Maintenance and Transport of Ammunition on Deployed Missions or Operations” vincolata al non superamento del valore di 4.000 kg di NEQ per ogni singolo PES.

- *Field Distances* (FD): distanza tra due PES per cui sono evitate le *prompt sympathetic detonations*, nonché la distanza tra un PES ed un ES per cui sono assicurati adeguati livelli di protezione.
- I valori *FD* sono ricavati dalla Table 2-2



Criteri di posizionamento di *Combat Aircraft*

Parking Area

- Si entra nella tabella individuando il PES che descrive i Combat Aircraft, ossia un velivolo non corazzato, con barricades;
- Tra gli Exposed Sites, si individua lo stesso pittogramma;
- Si valuta la FD tra i 4 aerei rischierati.

AASTP-5 Table 2-2		Matrix for Ammo Field Storage Distances for Deployed Missions or Operations											
		PES											
		VEHICLES					STRUCTURES (notes 11 & 12)						
		HEAVY ARMoured (notes 1 & 6)	LIGHT ARMoured (note 6)	NON-ARMoured (note 6)	HARDENED (note 6)	SEMI-HARDENED (note 6)	OPENLIGHT	HEAVY ARMoured (notes 1 & 6)	LIGHT ARMoured (note 6)	NON-ARMoured (note 6)	HARDENED (note 6)	SEMI-HARDENED (note 6)	
BARRICADED		UN-BARRICADED		BARRICADED		UN-BARRICADED		BARRICADED		UN-BARRICADED			
ES		APPLICABLE FD's											
ES CONTAINING EXPLOSIVES (note 2 and 12)	HEAVY ARMoured (note 6)	NO FD (note 6)	NO FD (note 6)	NO FD (note 6)	FD1	FD1	FD1	FD1	FD1	FD1	FD1	FD1	
	LIGHT ARMoured (note 6)	NO FD (note 6)	NO FD (note 6)	NO FD (note 6)	FD1	FD1	FD1	FD1	FD1	FD1	FD1	FD1	
	NON-ARMoured (note 6)	BARRICADED	UN-BARRICADED	FD1	FD1	FD3	FD1	FD3	FD1	FD1	FD3	FD1	FD3
	HARDENED (note 6)	BARRICADED	UN-BARRICADED	FD1	FD1	FD1	FD1	FD1	FD1	FD1	FD1	FD1	FD1
	SEMI-HARDENED (note 6)	BARRICADED	UN-BARRICADED	FD1	FD1	FD2	FD1	FD2	FD1	FD1	FD2	FD1	FD2
	OPENLIGHT STRUCTURE	BARRICADED	UN-BARRICADED	FD1	FD1	FD3	FD1	FD3	FD1	FD1	FD3	FD1	FD3
	AMMO WORKSHOP (note 4)	BARRICADED	UN-BARRICADED	FD1	FD1	FD3	FD1	FD3	FD1	FD1	FD3	FD1	FD3
EXPOSED SITES WITHOUT EXPLOSIVES (notes 3, 9 and 12)	HARDENED (notes 6 and 10)	BARRICADED	UN-BARRICADED	FD10	FD4	FD4	FD4	FD4	FD4	FD4	FD4	FD4	FD4
	SEMI-HARDENED (note 10)	BARRICADED	UN-BARRICADED	FD10	FD5	FD6	FD5	FD6	FD5	FD5	FD6	FD5	FD6
	LIGHT STRUCTURE	BARRICADED	UN-BARRICADED	FD10	FD8/FD7 (note 7)	FD8/FD7 (note 7)	FD8/FD7 (note 7)	FD8/FD7 (note 7)	FD8/FD7 (note 7)	FD8/FD7 (note 7)	FD8/FD7 (note 7)	FD8/FD7 (note 7)	FD8/FD7 (note 7)
	OPEN PERSONNEL MISSION RELATED	BARRICADED	UN-BARRICADED	FD10	FD8	FD9	FD8	FD9	FD8	FD8	FD9	FD8	FD9
	UNPROTECTED PEOPLE OUTSIDE COMPOUND	BARRICADED	UN-BARRICADED	FD10	FD9	FD9	FD9/FD8 (note 08)	FD9	FD8	FD9/FD8 (note 08)	FD9	FD9/FD8 (note 08)	FD9
	UNPROTECTED PEOPLE OUTSIDE COMPOUND	BARRICADED	UN-BARRICADED	FD10	FD9	FD9	FD9/FD8 (note 08)	FD9	FD8	FD9/FD8 (note 08)	FD9	FD9/FD8 (note 08)	FD9
	UNPROTECTED PEOPLE OUTSIDE COMPOUND	BARRICADED	UN-BARRICADED	FD10	FD9	FD9	FD9/FD8 (note 08)	FD9	FD8	FD9/FD8 (note 08)	FD9	FD9/FD8 (note 08)	FD9



Criteri di posizionamento di *Combat Aircraft*

Parking Area

QD tra C.A.P.A. da rischieramento

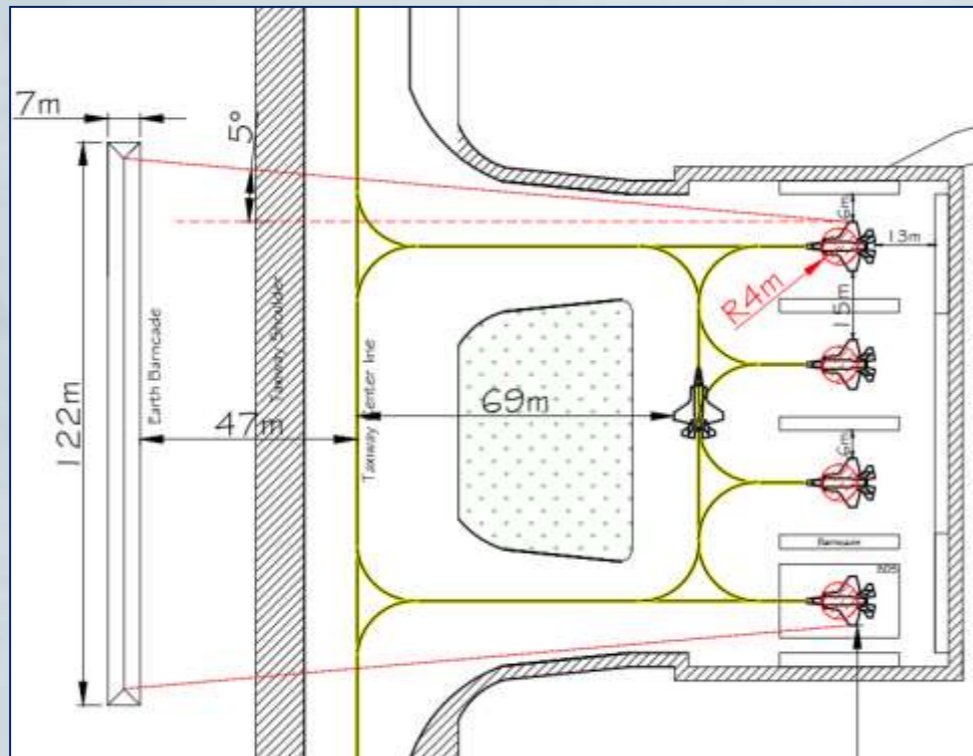

AASTP-5 Table 2-3	FIELD DISTANCES (FD's) (AASTP-5 Criteria)									
	PES to ADJACENT PES					PES to ES (NON PES)				
	NEQ	FD1	FD2	FD3	FD4	FD5	FD6	FD7	FD8	FD9
25		7	14	12	18	23	23	100	130	13
50		9	18	15	22	30	33	100	212	21
75		10	20	17	25	34	40	100	260	27
100		11	22	19	28	37	46	100	294	32
150		13	26	21	32	43	56	100	342	42
250		15	30	25	38	51	73	100	400	400
500		4	19	38	32	48	64	103	155	400
750		4	22	44	37	55	73	118	203	400
1000		4	24	48	40	60	80	130	235	400
1500		7	28	55	46	69	92	149	283	400
2000		8	30	61	51	76	101	164	320	400
2500		8	33	65	54	82	109	177	352	400
3000		9	35	69	58	87	116	188	381	400
4000		10	38	76	64	95	127	207	400	400



CONCLUSIONI

- La *Hazardous Cargo Pad* e le diverse configurazioni delle *Combat Aircraft Parking Area* risultano perfettamente compatibili;
- Tale soluzione garantisce flessibilità di rischieramento nel rispetto della standardizzazione delle normative NATO cogenti.

Grazie per la Vostra Attenzione!



**Progettazione di Hazardous Cargo Pad e
Combat Aircraft Parking Area per
rischieramento Forze NATO**

INNOVAZIONE LOGISTICA OPERATIVA **QUEMILA 23**



COMANDO LOGISTICO AM