

Schlüter-Systems Italia



Chi è Schlüter?



**Werner
Schlüter**

- 1966:** Viene fondata l'azienda specializzata nella posa
- 1975:** Sviluppo dello Schiene
- Oggi:** Oltre 4000 prodotti
Oltre 900 dipendenti
Circa 500.000.000 €
di fatturato

Schlüter[®]-Systems

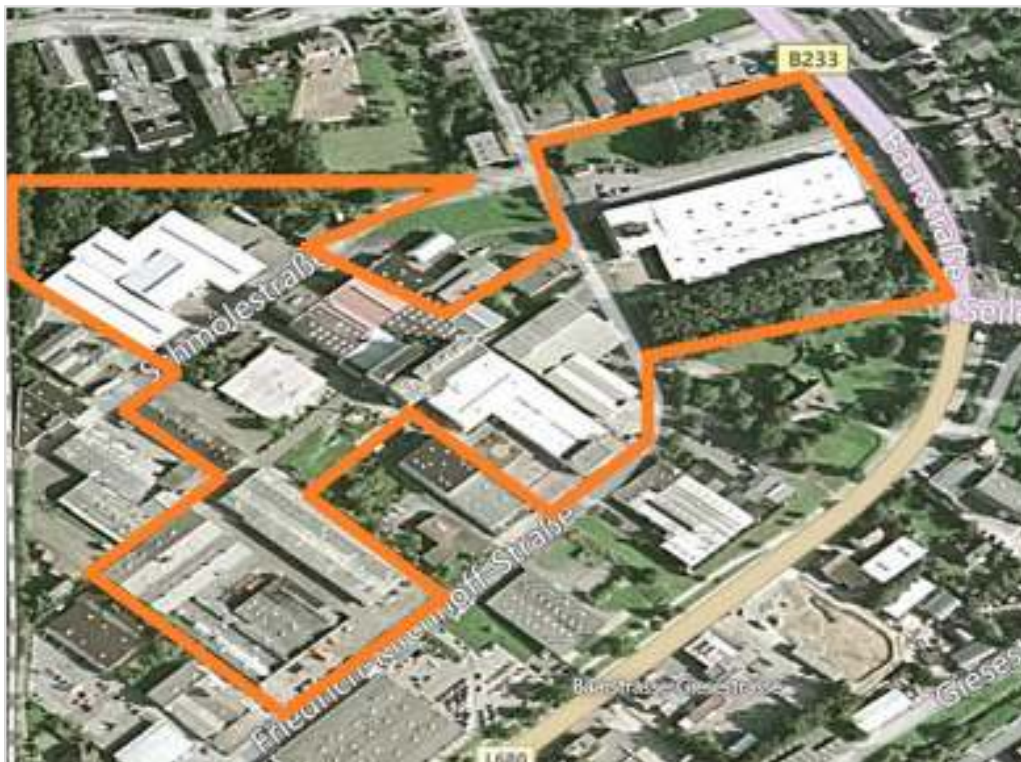

SEDE ISERLOHN



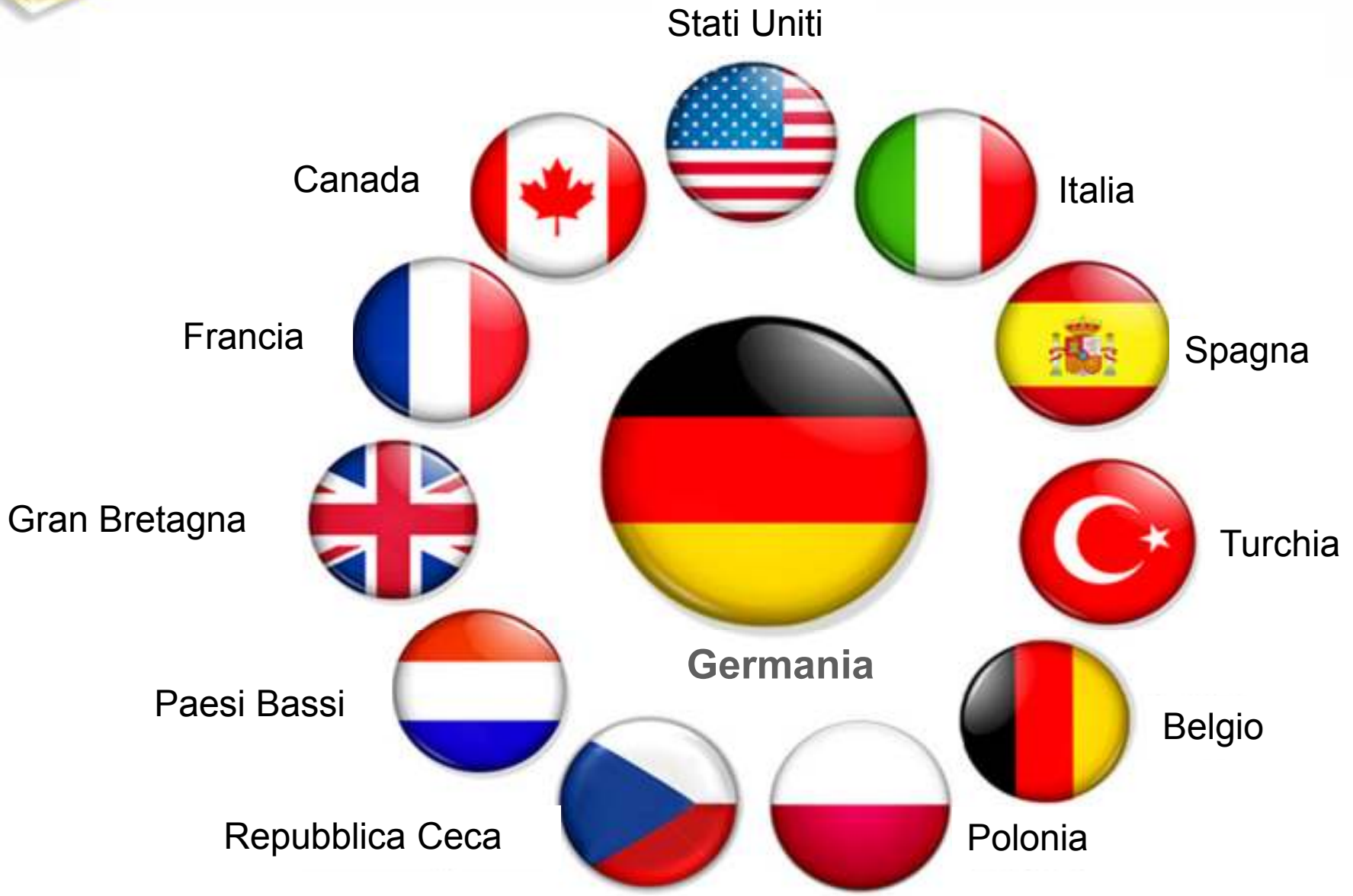
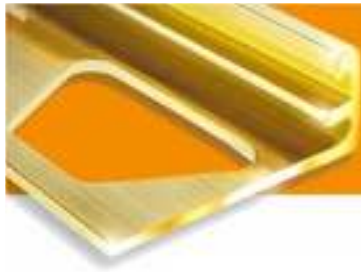

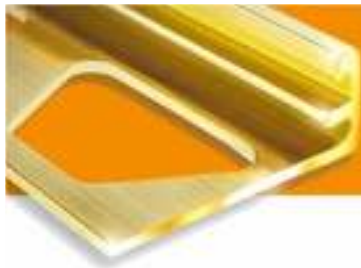

La nostra sede di Fiorano Modenese



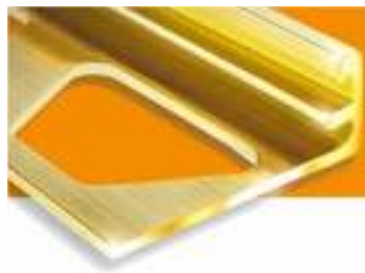

La nostra sede di Fiorano Modenese



Uffici



**Centro
di Formazione Nazionale**

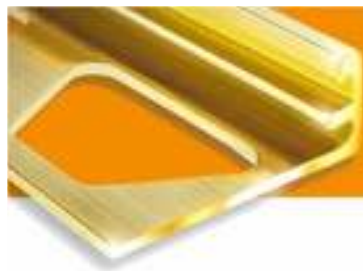

Facciamo parte del GL delle Norme



come

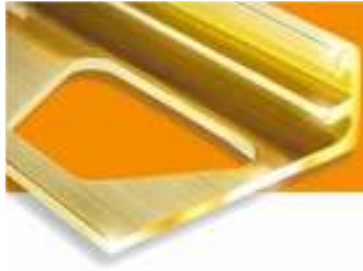

Progettazione della piastrellatura



UNI 11493

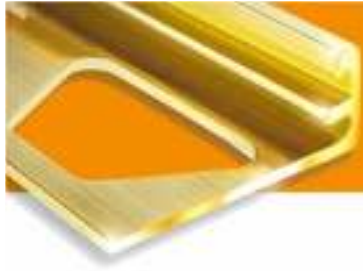

La



Piastrellatura

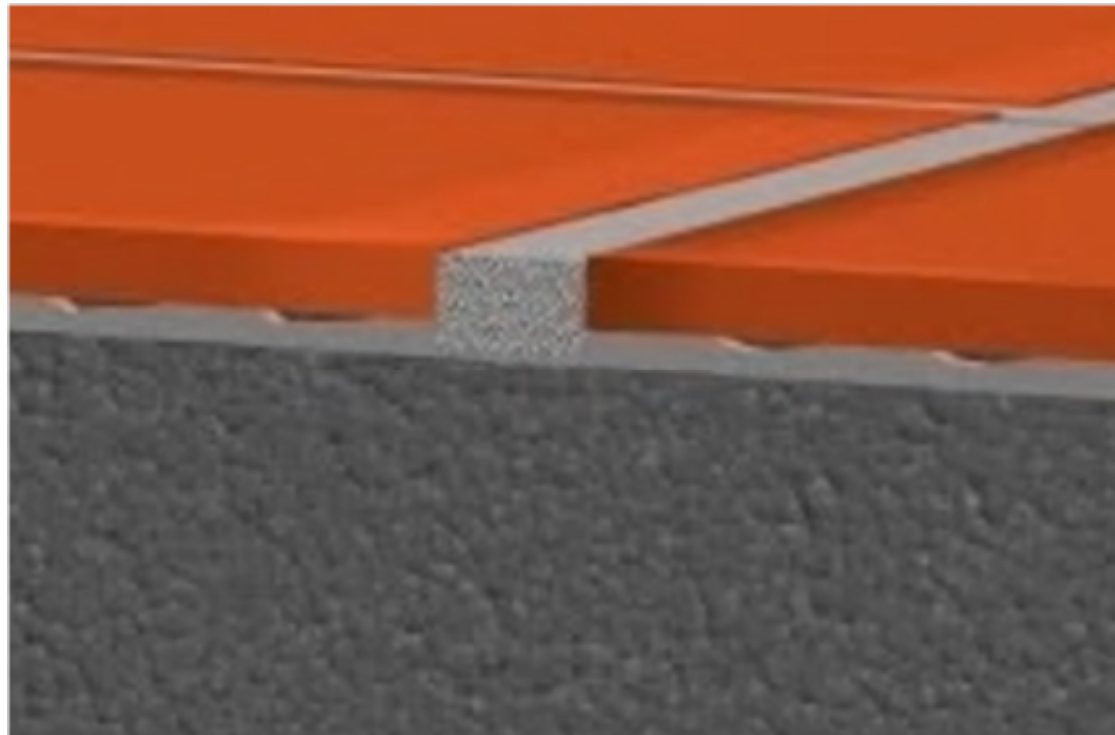

UNI 11493

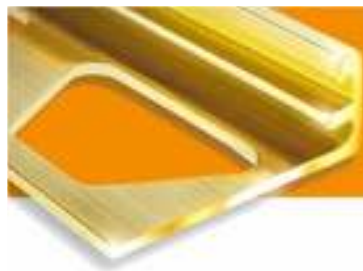

Progettazione della Copertura Piana



UNI 8627 – UNI 8178

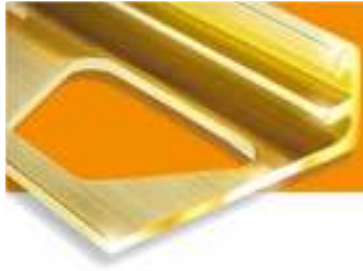

La



Copertura Piana

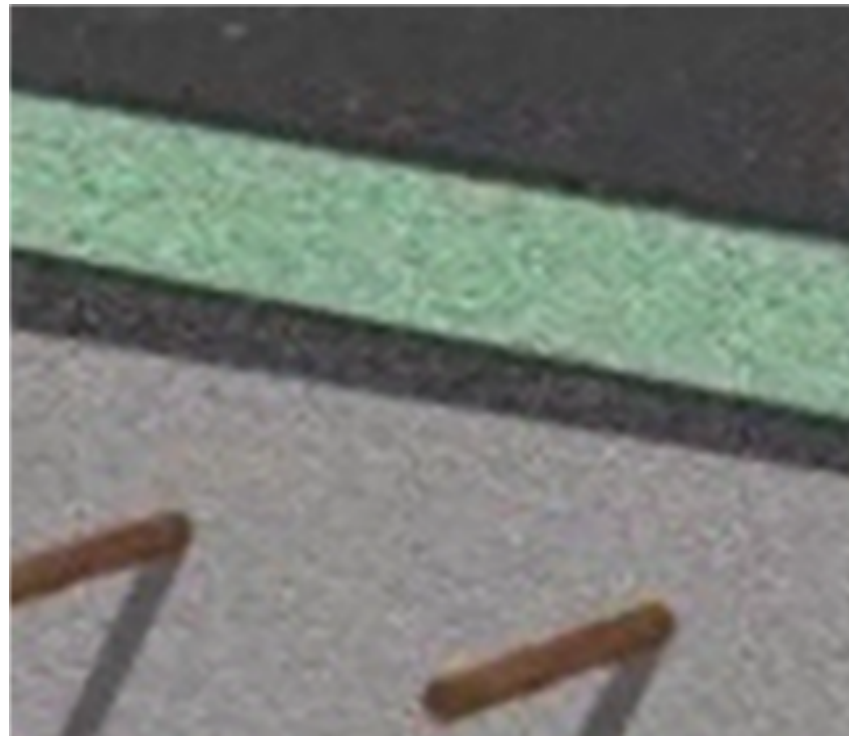

UNI 8627 – UNI 8178

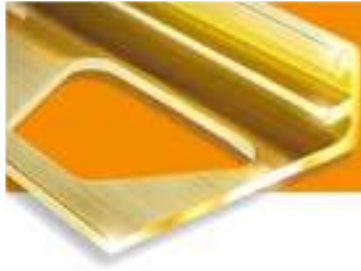

Partner Tecnici



Assoposa



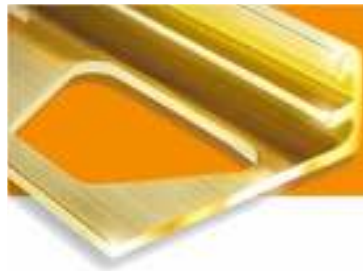

Partner Tecnici



ASSOCIAZIONE NAZIONALE IMPRESE DI POSA E INSTALLATORI DI PIASTRELATURE CERAMICHE

AREA RISERVATA CERCA NEL SITO

ASSO POSA

NASCE LA
**POSA
QUALIFICATA**

ASSOPOSA ASSOCIATI PARTNER CORSI DI QUALIFICA

HOME >

ASSOCIAZIONE
30/09/2014

Colebbo al Cersaie- "Ora i rivenditori"

"Abbiamo avviato il processo (riguardo i piastrellisti), ora è il momento di passare alla qualificazione dei rivenditori": questo, in sintesi, lo...

LEGGI >

ASSOCIAZIONE
18/09/2014

Assoposa su Uno Mattino- la buona posa entra nelle case

Sembra che ormai sempre più persone si stiano rendendo conto di come un buon pavimento non possa prescindere da una buona posa: tanto che anche...

LEGGI >

ASSOCIAZIONE
17/09/2014

Assoposa al Cersaie- gli appuntamenti da non perdere

ASSOCIAZIONE
17/09/2014

Il Sole 24 Ore- Assoposa e UNI, Italia supera l'UE

LA GARANZIA ASSOPOSA PER PAVIMENTAZIONI A REGOLA D'ARTE!

Rivolgersi a un rivenditore o a un piastrellista Assoposa significa servirsi di professionisti esperti e qualificati.

PERCHÉ SCEGLIERE UN ASSOCIATO ASSOPOSA >

TROVA
SERVIZIO DI POSA ASSOPOSA

PARTNER TECNICI

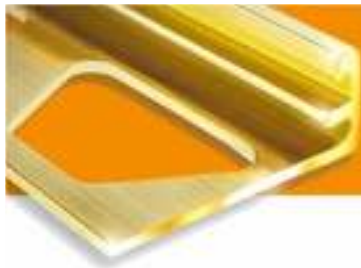

Associati



ASSIMP
ITALIA

Associazione delle Imprese di Impermeabilizzazione Italiane

NETWORKING | TECNOLOGIA | FORMAZIONE



I Nostri Sistemi

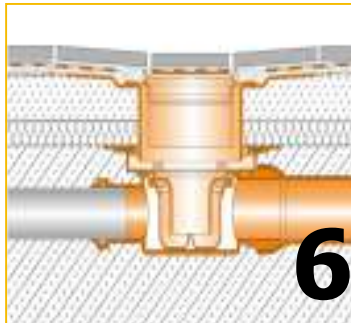
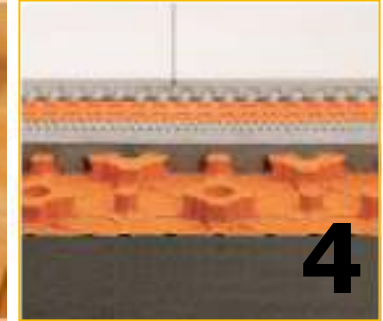
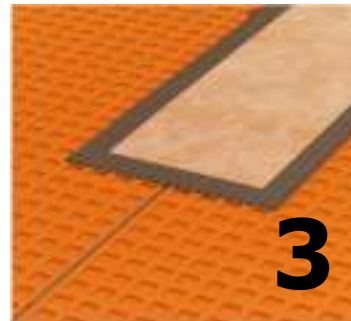
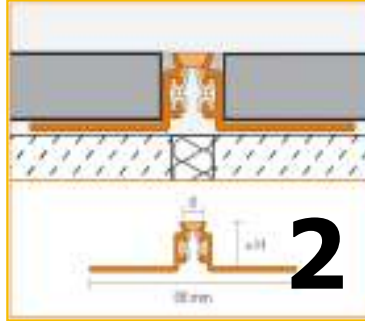

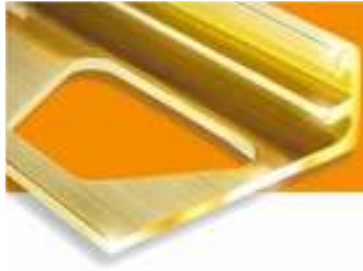

Terrazzi (balconi) senza problemi

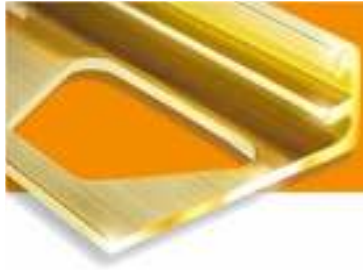

Il 50% delle cause edili
in Italia sono dovute
all'impermeabilizzazione.

Di questo il 54% è dovuto
ad un'errata progettazione

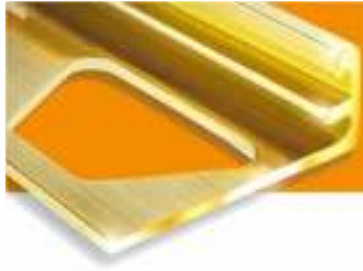

Progettazione



Terrazzo

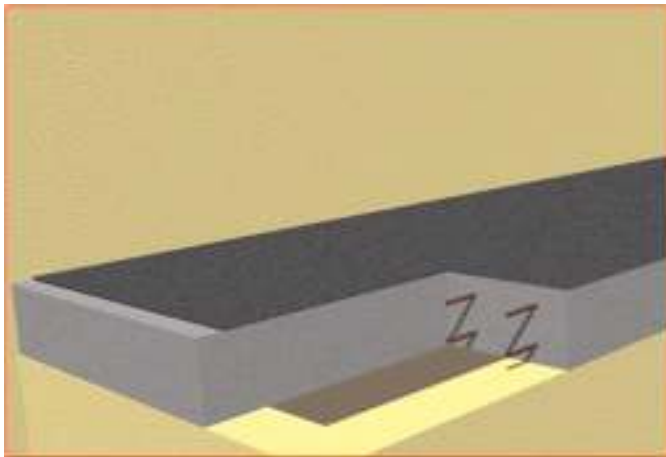

Balcone

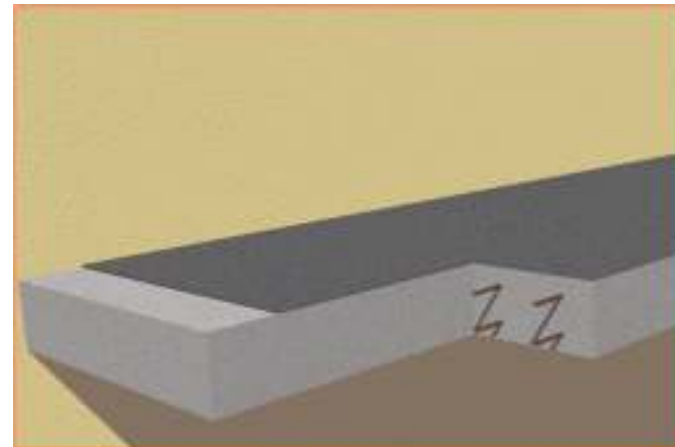

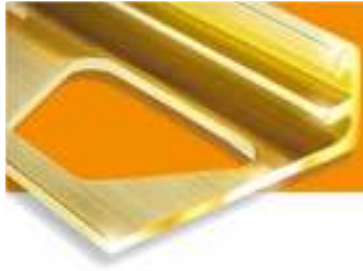

Quali sono
questi problemi?

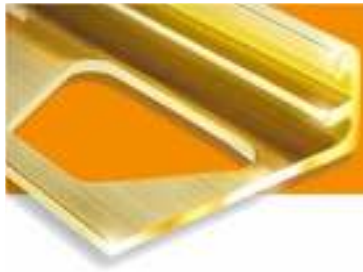

Problema



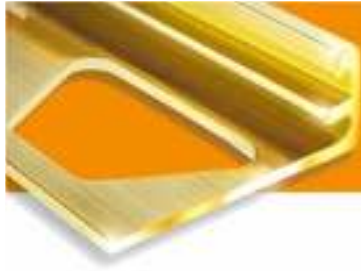

Problema



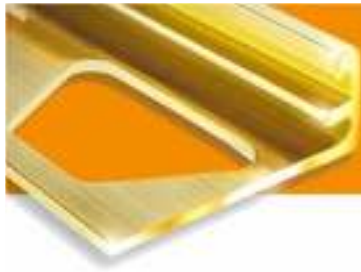

Problema



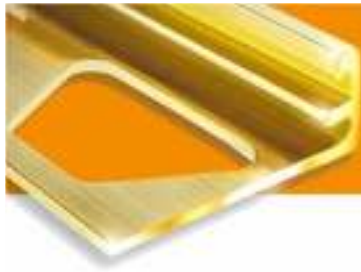

Problemi





Progettazione



Terrazzo

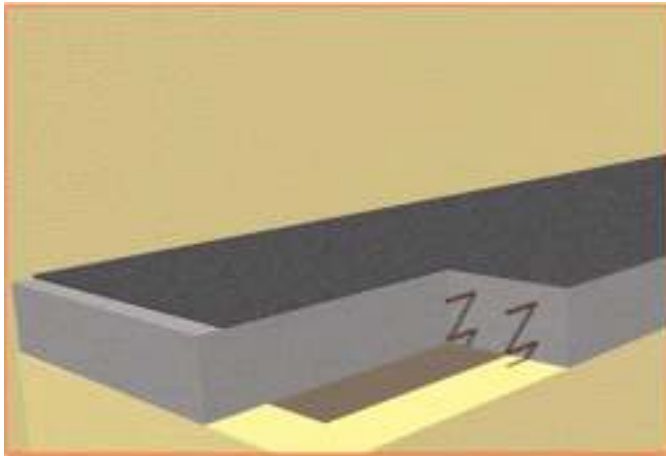

Balcone

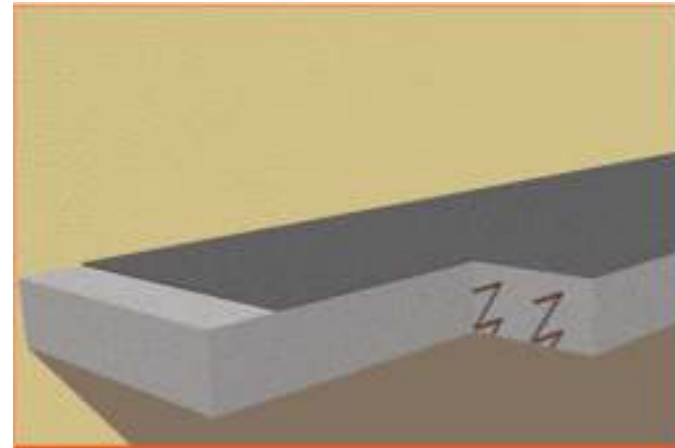

Piastrellatura

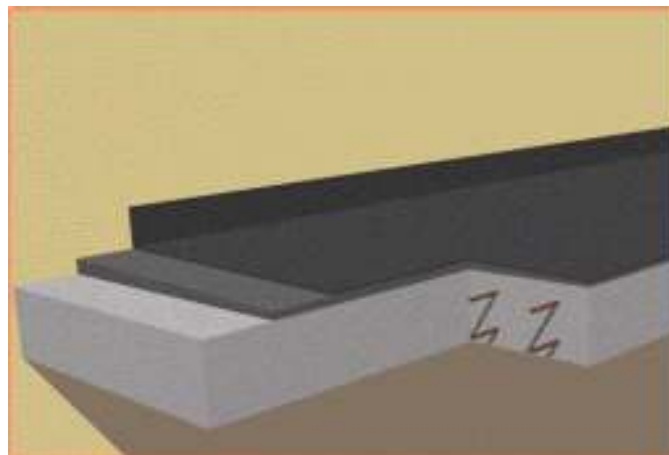

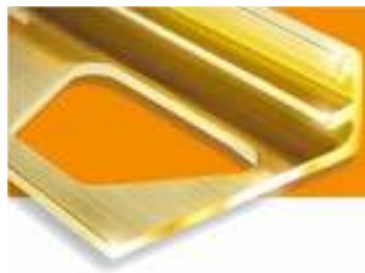

Progettazione



Quindi...

...la piastrellatura di un
terrazzo secondo le norme

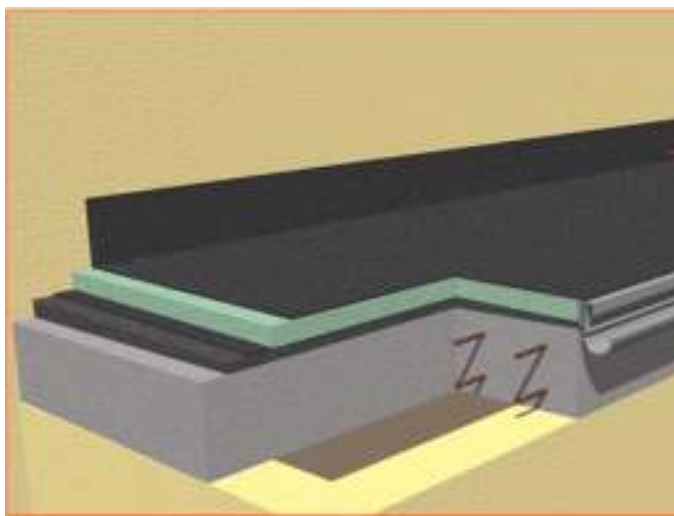

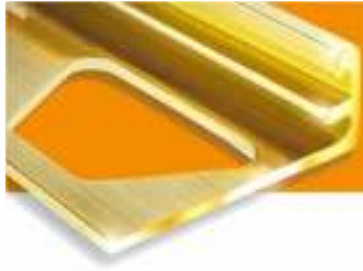

**Le soluzioni sono
impermeabilizzare e/o drenare
la piastrellatura.**

Sistemi

Schlüter[®]-DITRA

Schlüter[®]TROBA

Drenare / Impermeabilizzare



Schlüter®-TROBA



Schlüter®-DITRA-DRAIN

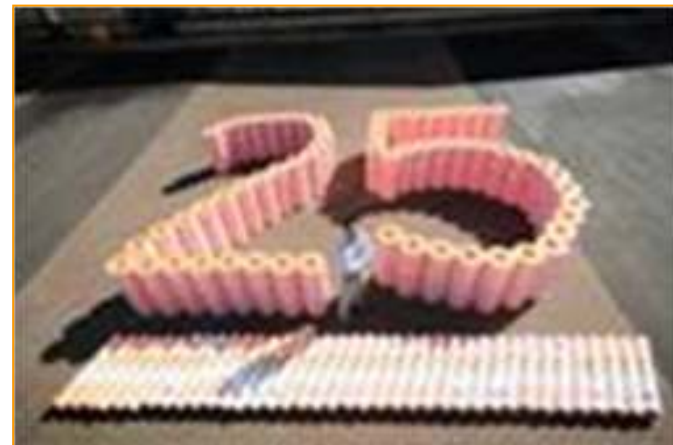

Schlüter®-DITRA 25

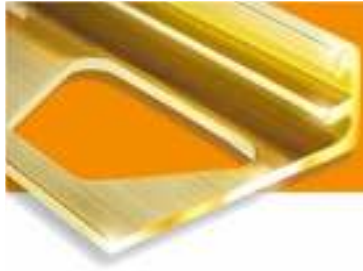

Drenare



Schlüter®-TROBA



Schlüter®-DITRA-DRAIN

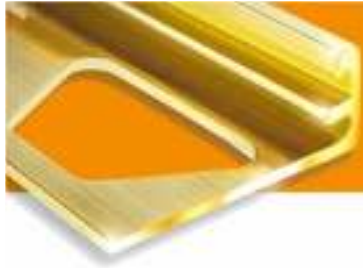

Sistema



Schlüter[®]-TROBA



Schlüter®-TROBA-PLUS

La soluzione

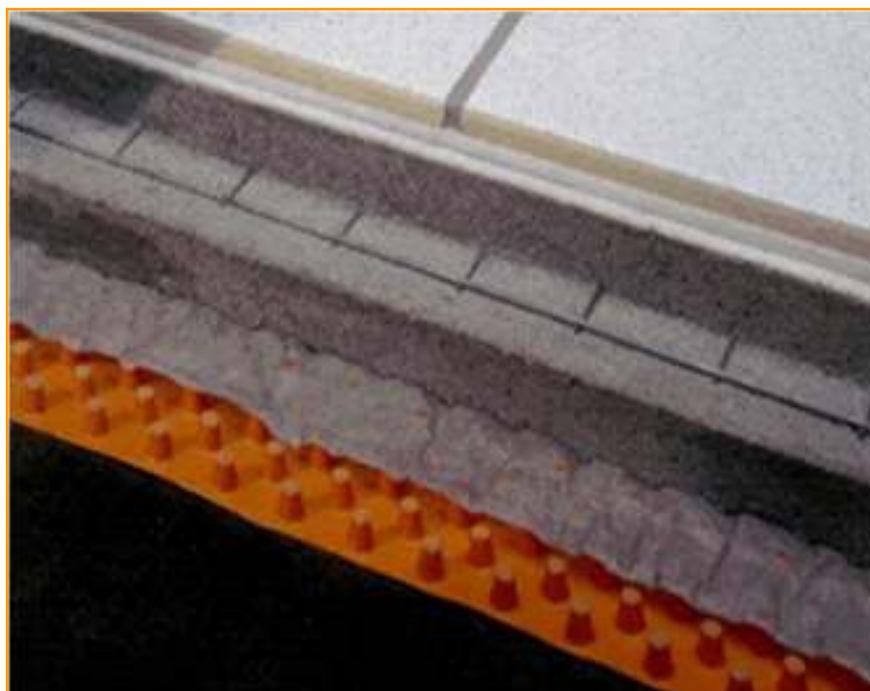

Altezze

8 e 12 mm

Resistenza agli agenti chimici

Resiste agli acidi,
alle soluzioni caustiche e agli oli.

Resistente al calore

Punto di rammollimento + 120° C
Stabilità dimensionale
da - 40 ° C a + 80° C.

Capacità di carico

30 t/mq Schlüter®-TROBA-PLUS12

39 t/mq Schlüter®-TROBA-PLUS8 -8G

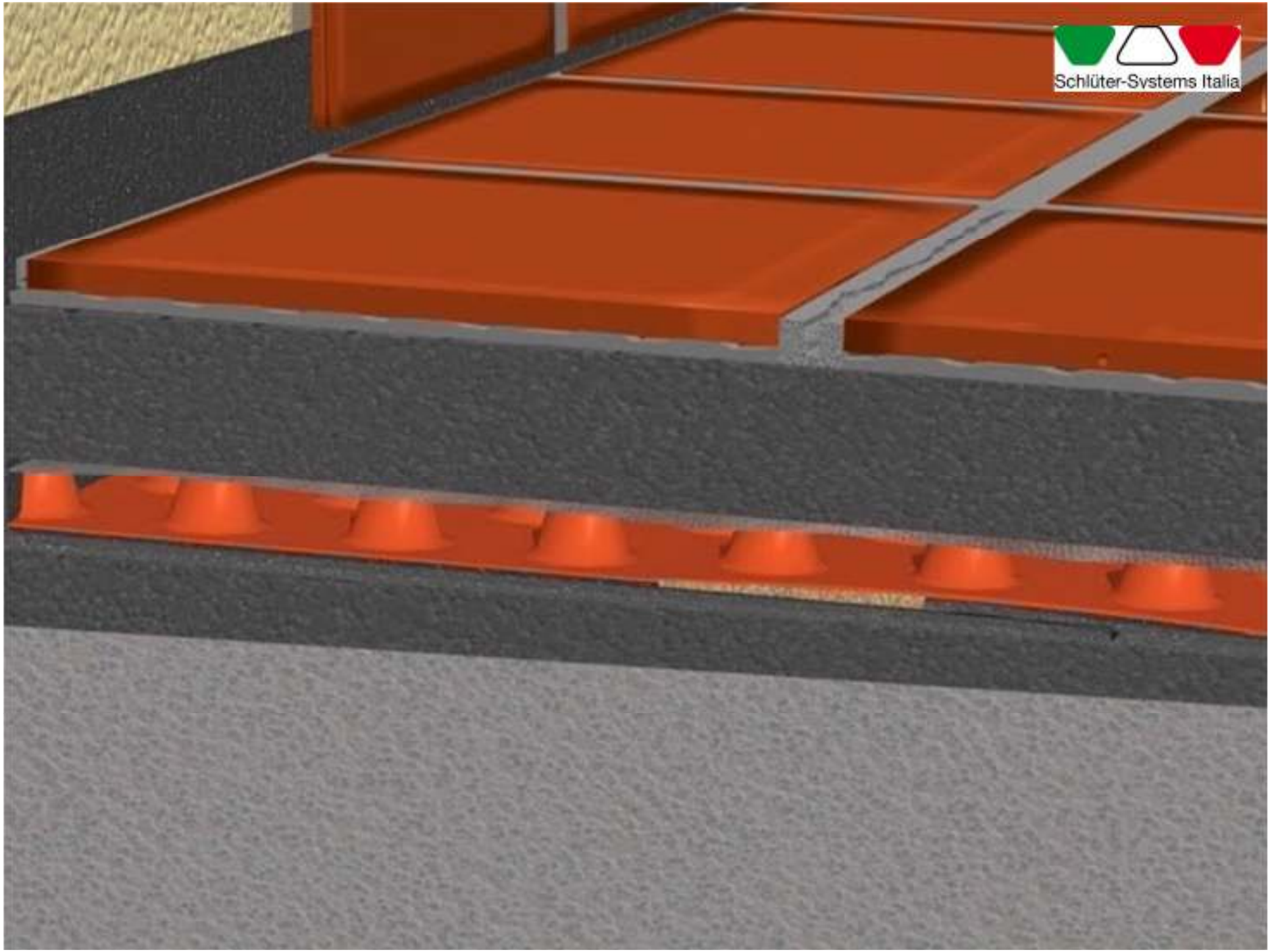

Altri sistemi Schlüter®-TROBA

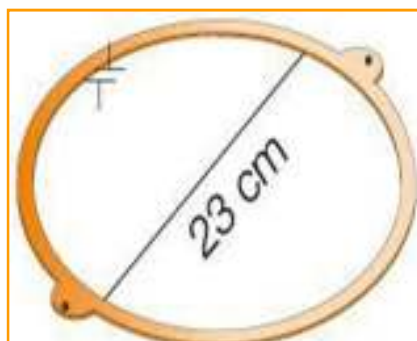

Sistemi per Schlüter®-TROBA

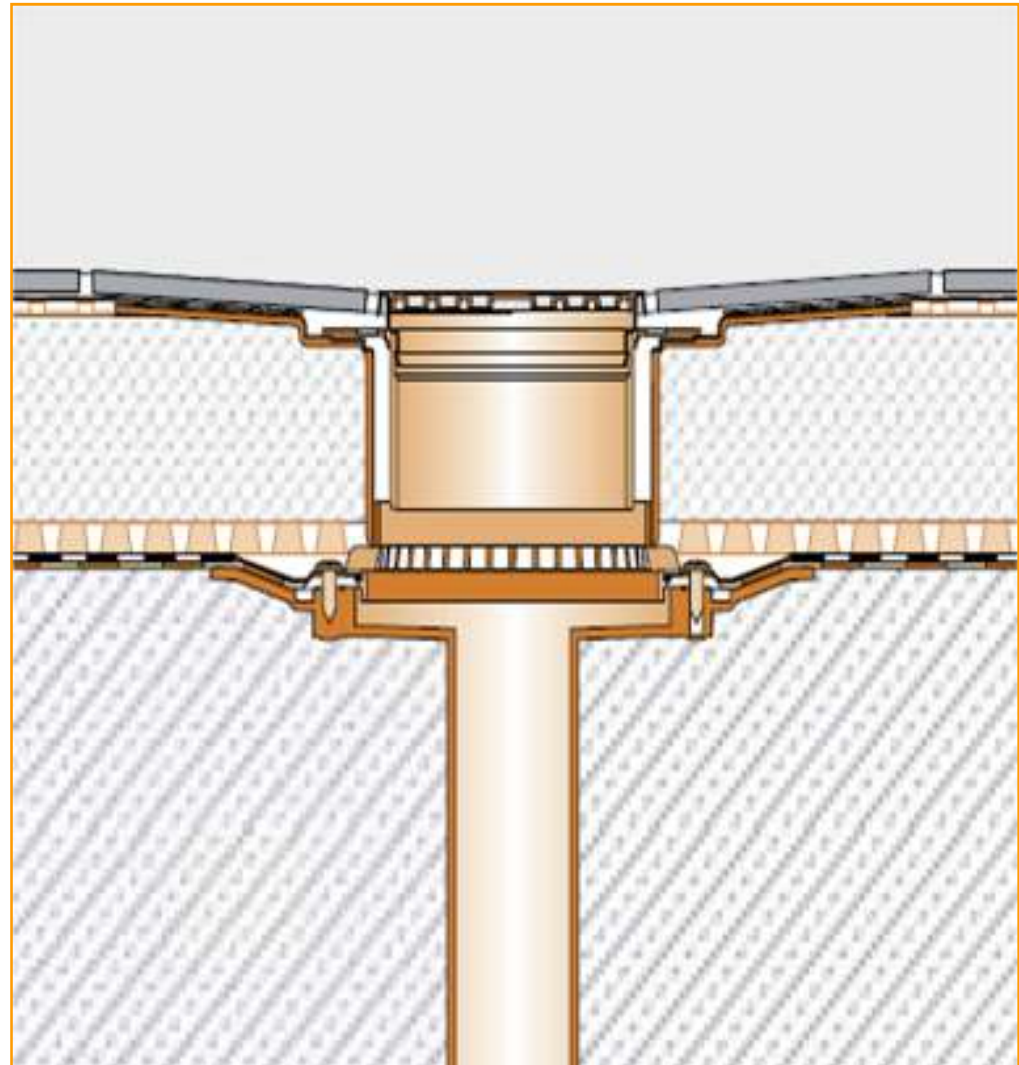

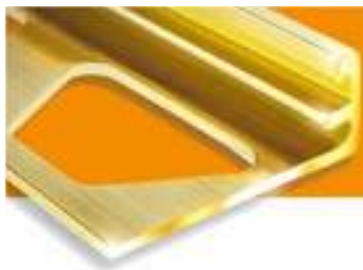

Schlüter®-TROBA

La soluzione

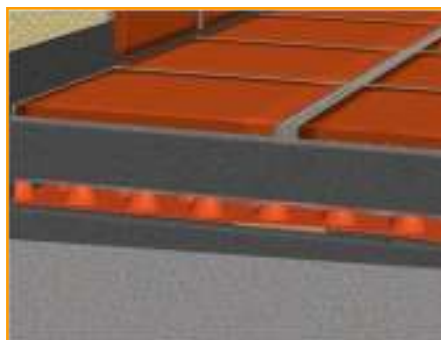

Drenaggio

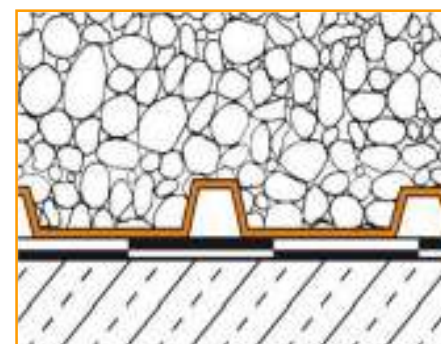

**Protezione del
manto
impermeabile e/o
barriera al vapore**



La Posa

La posa dei sistemi **Schlüter®-TROBA** risultano molto semplici e non sono necessarie particolari attrezzature; sono infatti sufficienti un cutter, e, nel caso del **Schlüter®-TROBA-STELZ** malta o collante.



Schlüter[®]-TROBA

Applicazione



Schlüter[®]-TROBA

Applicazione



Schlüter[®]-TROBA

Alcune applicazioni

Pista Bosch



Schlüter[®]-TROBA

Alcune applicazioni



Schlüter[®]-TROBA

Applicazione



Schlüter[®]-TROBA-STELZ

Applicazione



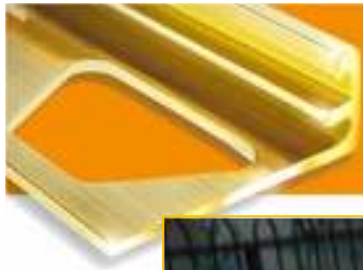

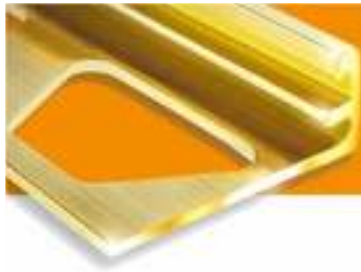

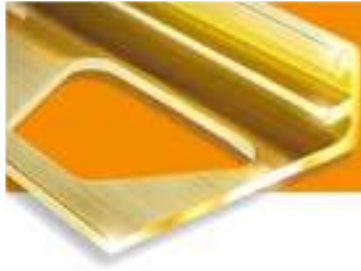

Impermeabilizzare Schlüter[®]-DITRA 25

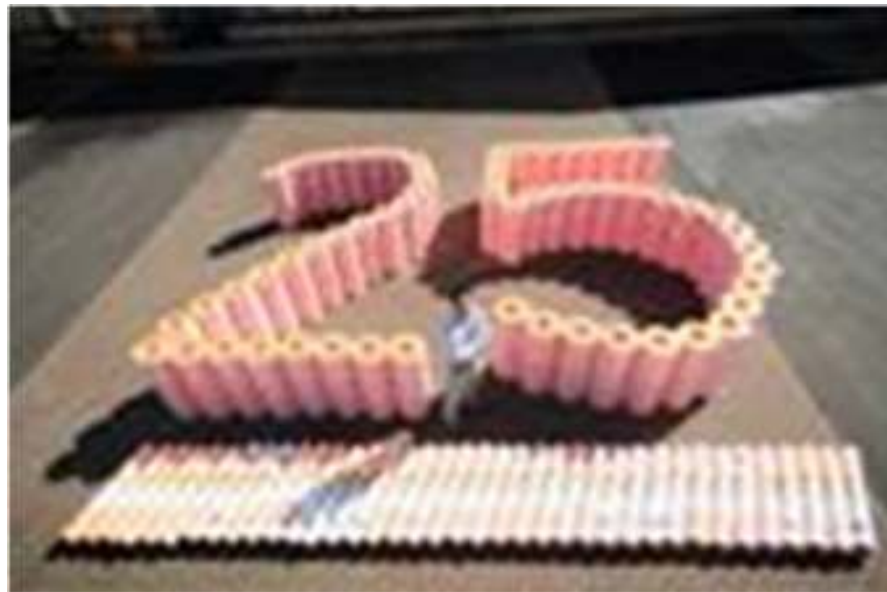



Schlüter®-DITRA 25

La soluzione

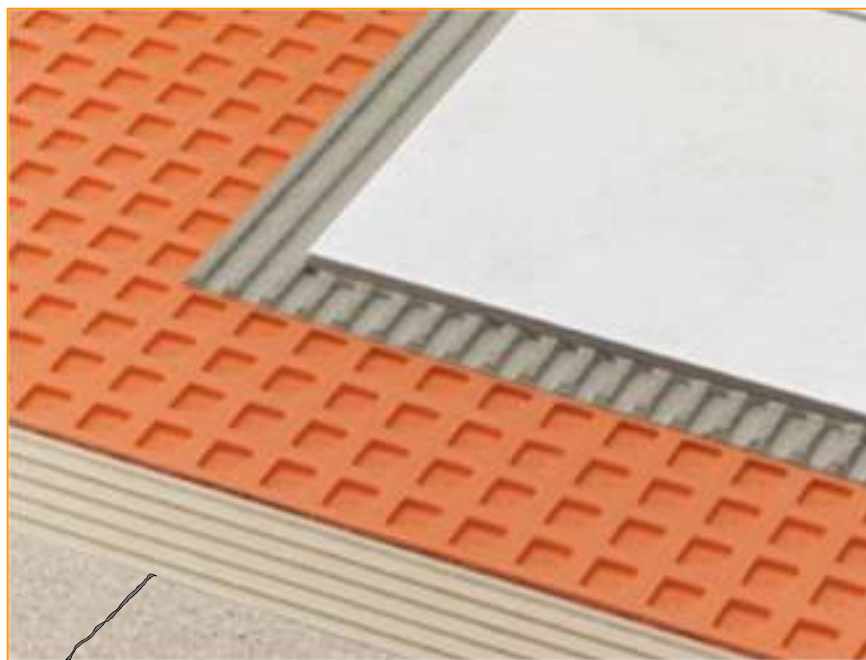

Resistenza agli agenti chimici

Resiste agli acidi, alle soluzioni caustiche e agli oli.

Impermeabile

Permeabilità al vapore

0,8 gr / m² x d

Resistente al calore

Punto di rammollimento + 120° C
Stabilità dimensionale da - 40 ° C
a + 80° C.

Idonea nel caso di riscaldamento a pavimento.

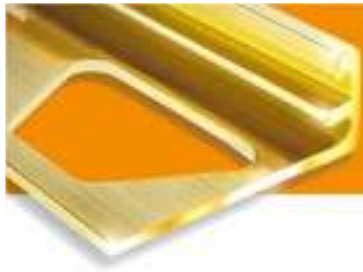

Schlüter[®]-DITRA 25

Funzioni



- Impermeabilizzazione
- Separazione
- Sfogo del vapore

Schlüter[®]-DITRA 25

Funzioni



Impermeabilizzazione



Separazione

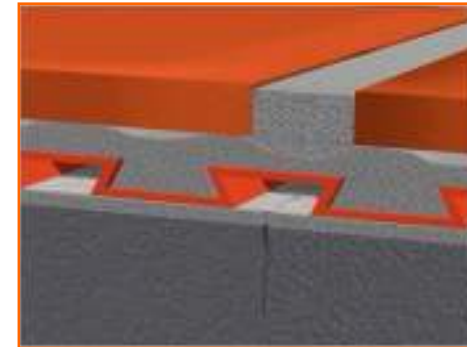

Sfogo del vapore

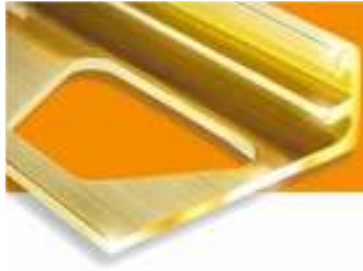

Schlüter[®]-DITRA 25

Impermeabilizzazione

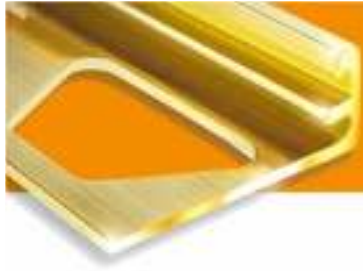

Schlüter[®]-DITRA 25

Applicazione

La posa della guaina risulta molto semplice e non sono necessarie particolari attrezzature; è infatti sufficiente un cutter, spatole dentate idonee e un normale collante presente in commercio

Schlüter[®]-DITRA 25

Applicazione

Stendere l'adesivo sul sottofondo con spatola dentata e posare la guaina Schlüter[®]-DITRA 25



Schlüter[®]-DITRA 25

Applicazione

Premere la guaina Schlüter[®]-DITRA 25 sull'adesivo con l'ausilio di un frattazzo.





Schlüter®-DITRA 25

Applicazione

Rasare con collante la guaina lungo la giunzione e sigillare la giunzione con la guaina Schlüter®-KERDI-KEBA.



Schlüter[®]-DITRA 25

Applicazione



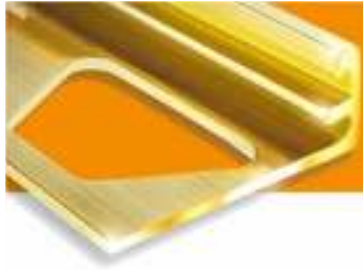

Schlüter[®]-DITRA 25

Applicazione

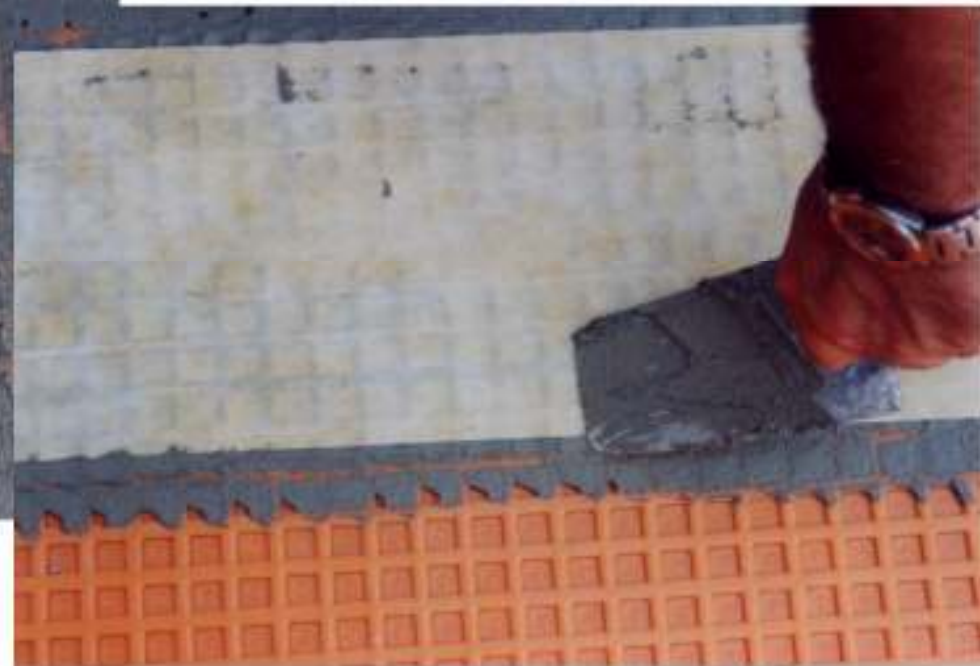

Schlüter[®]-DITRA 25

Applicazione

Stendere collante lungo il perimetro ed applicare la guaina Schlüter[®]-KERDI-KEBA.



Schlüter®-DITRA 25

Applicazione

Posizionare il giunto Schlüter®-DILEX-EK e rasare la guaina con il collante.



Schlüter[®]-DITRA 25

Applicazione

Dopo aver rasato la guaina Schlüter[®]-DITRA 25, fresco su fresco, posare il pavimento



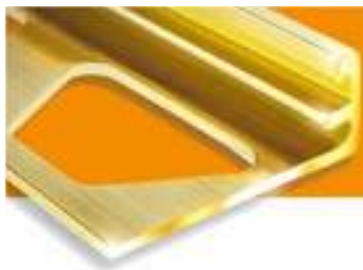

Schlüter[®]-DITRA 25

Vantaggi

Stuccare e lavare.



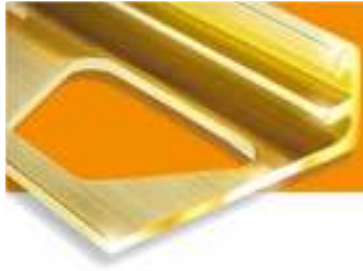

Schlüter[®]-DITRA 25

Separazione

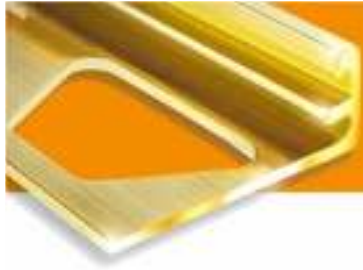

Schlüter[®]-DITRA 25



Perché è necessario uno strato di separazione?

Perché le crepe del massetto arrivano in superficie.

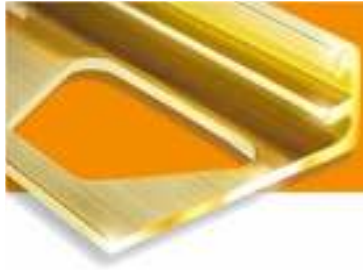

Schlüter®-DITRA 25



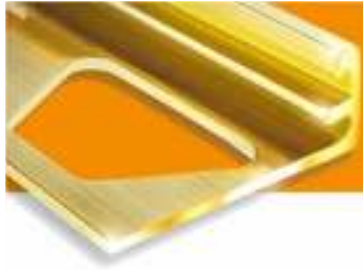

Schlüter[®]-DITRA 25



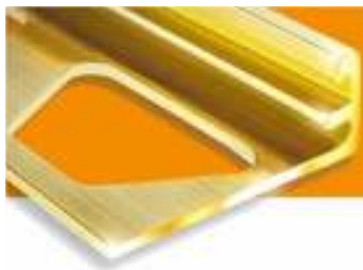

Schlüter[®]-DITRA 25

Escursione 70 °C

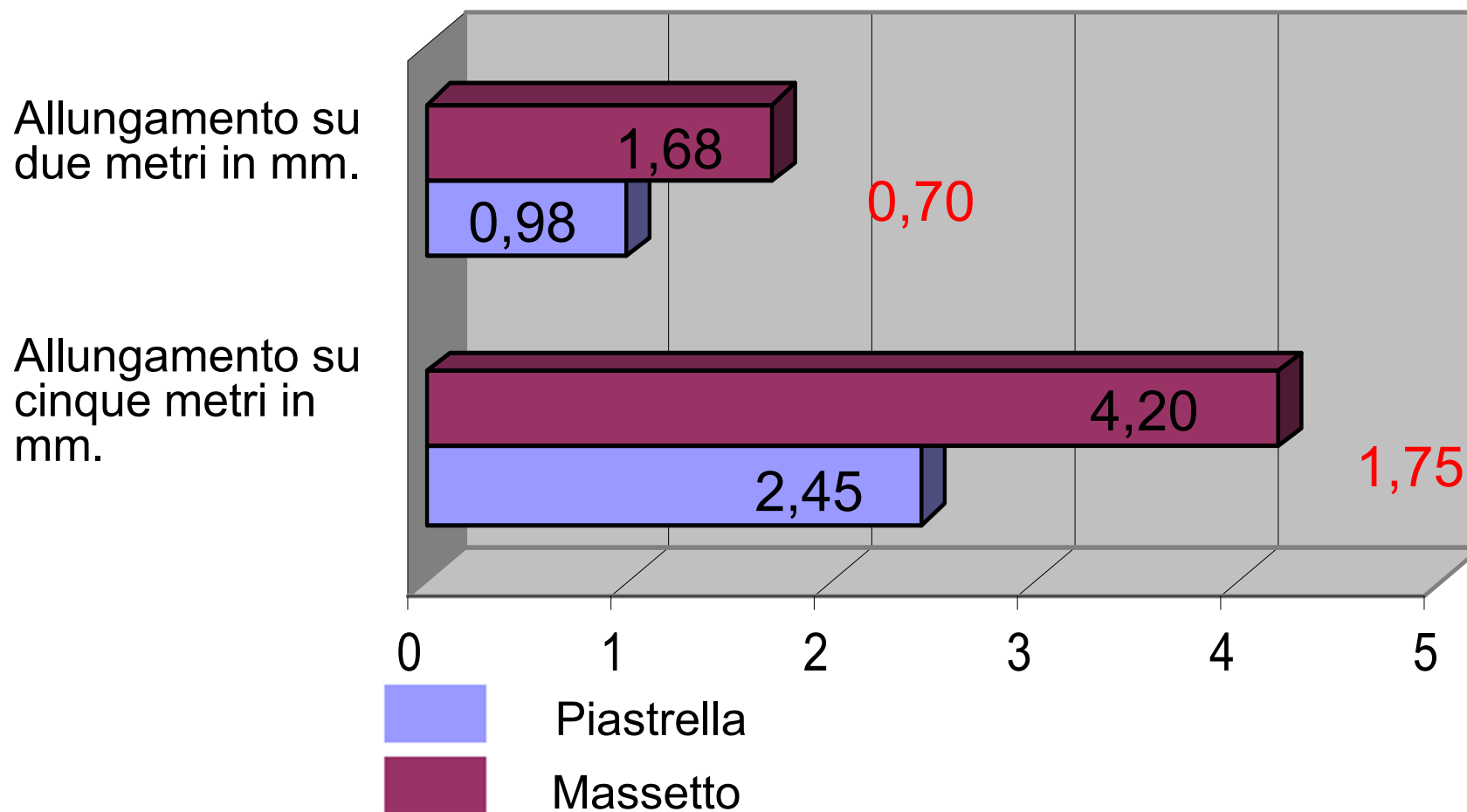

A high-angle photograph of a circular atrium. The floor is composed of large, light-colored tiles arranged in a complex geometric pattern of triangles and circles. In the center, there is a circular planter with a tiered, orange-colored border, containing a small Christmas tree and yellow and blue decorations. To the right, a staircase with a dark metal railing is visible. The overall scene is brightly lit, suggesting an indoor public space.

Il vostro lavoro è realizzare questa superficie

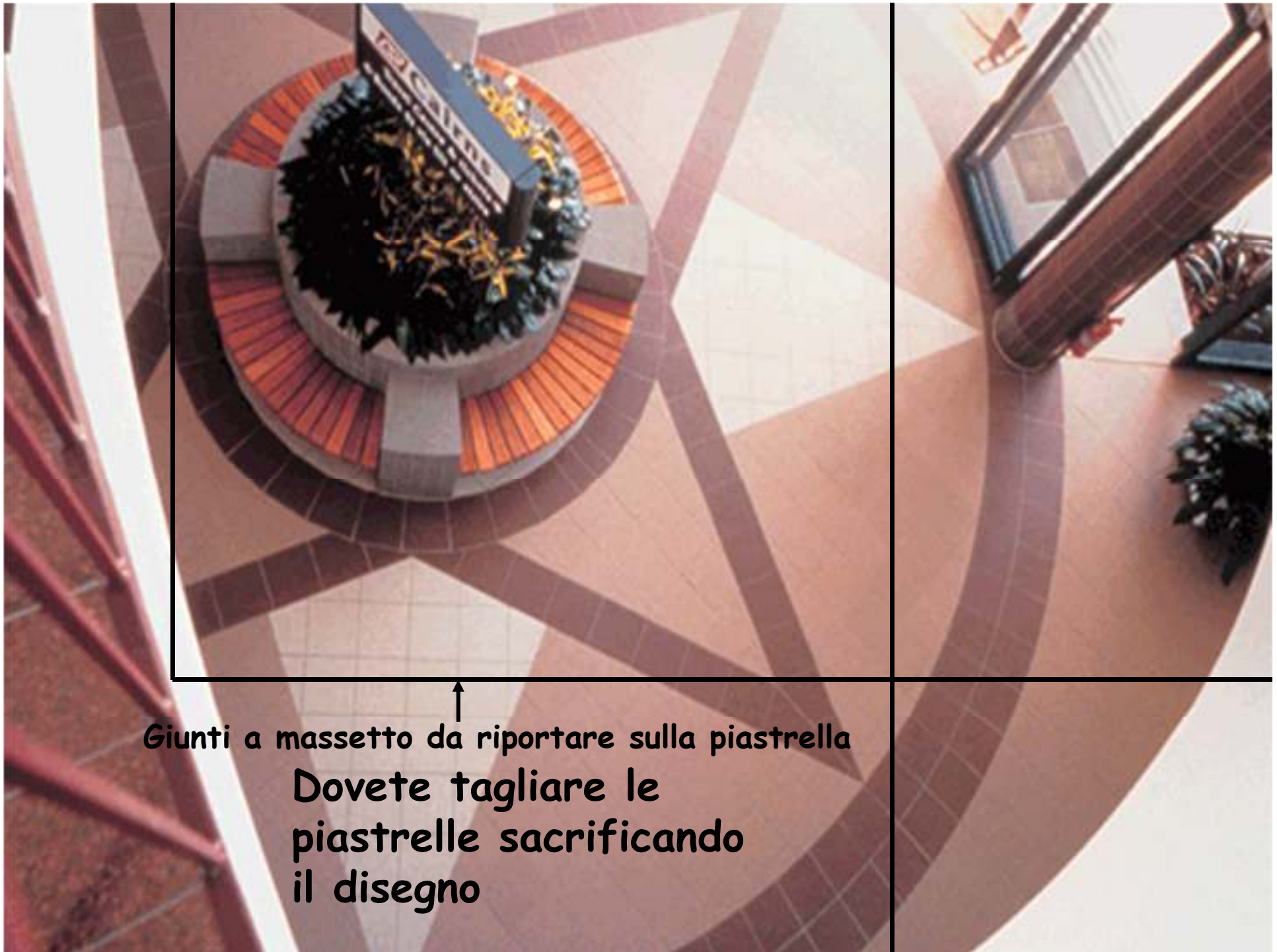

Giunti a massetto da riportare sulla piastrella
Dovete tagliare le
piastrelle sacrificando
il disegno

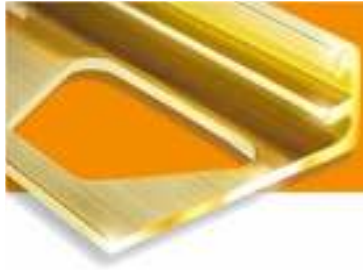

Schlüter[®]-DITRA 25

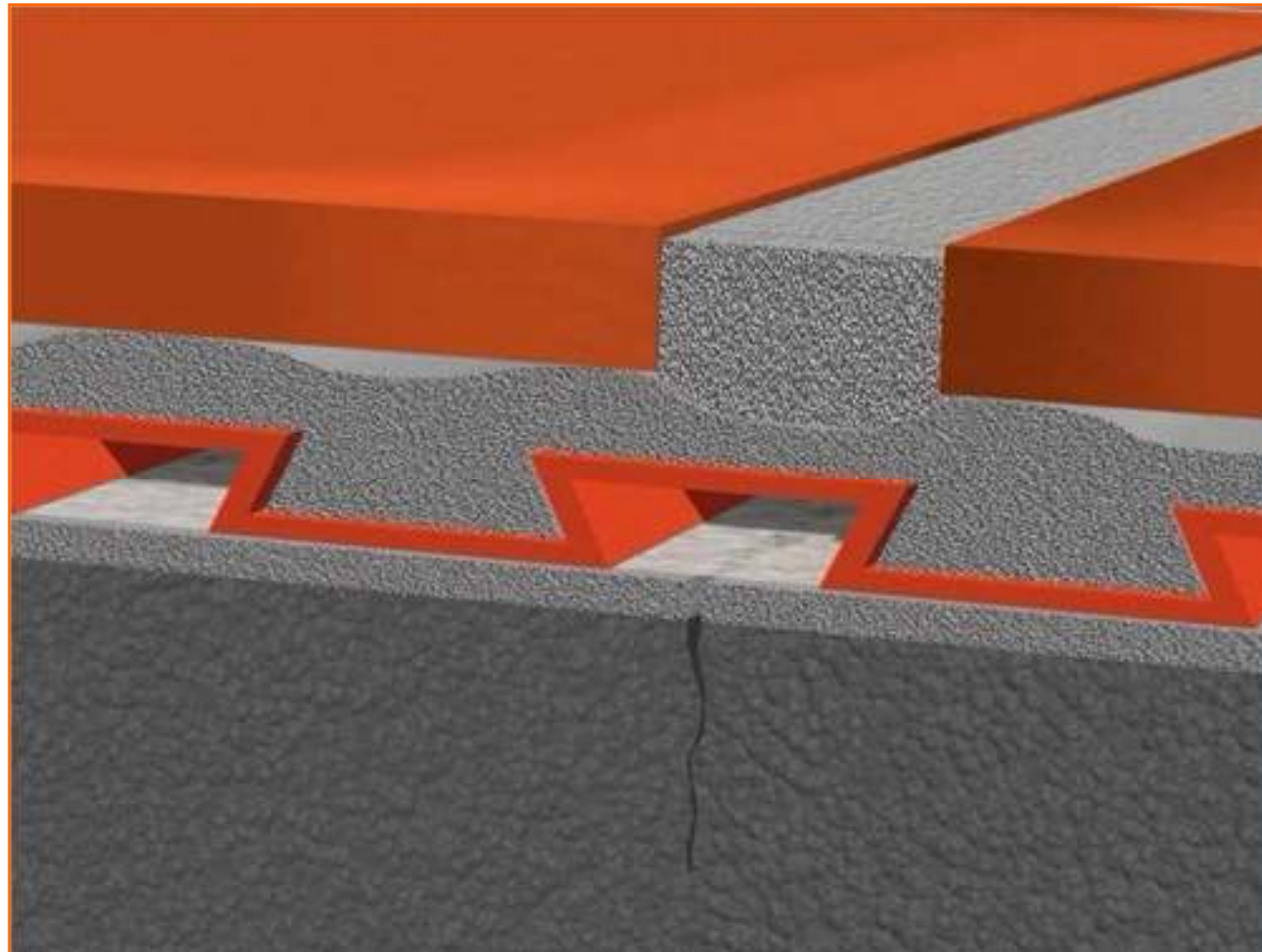

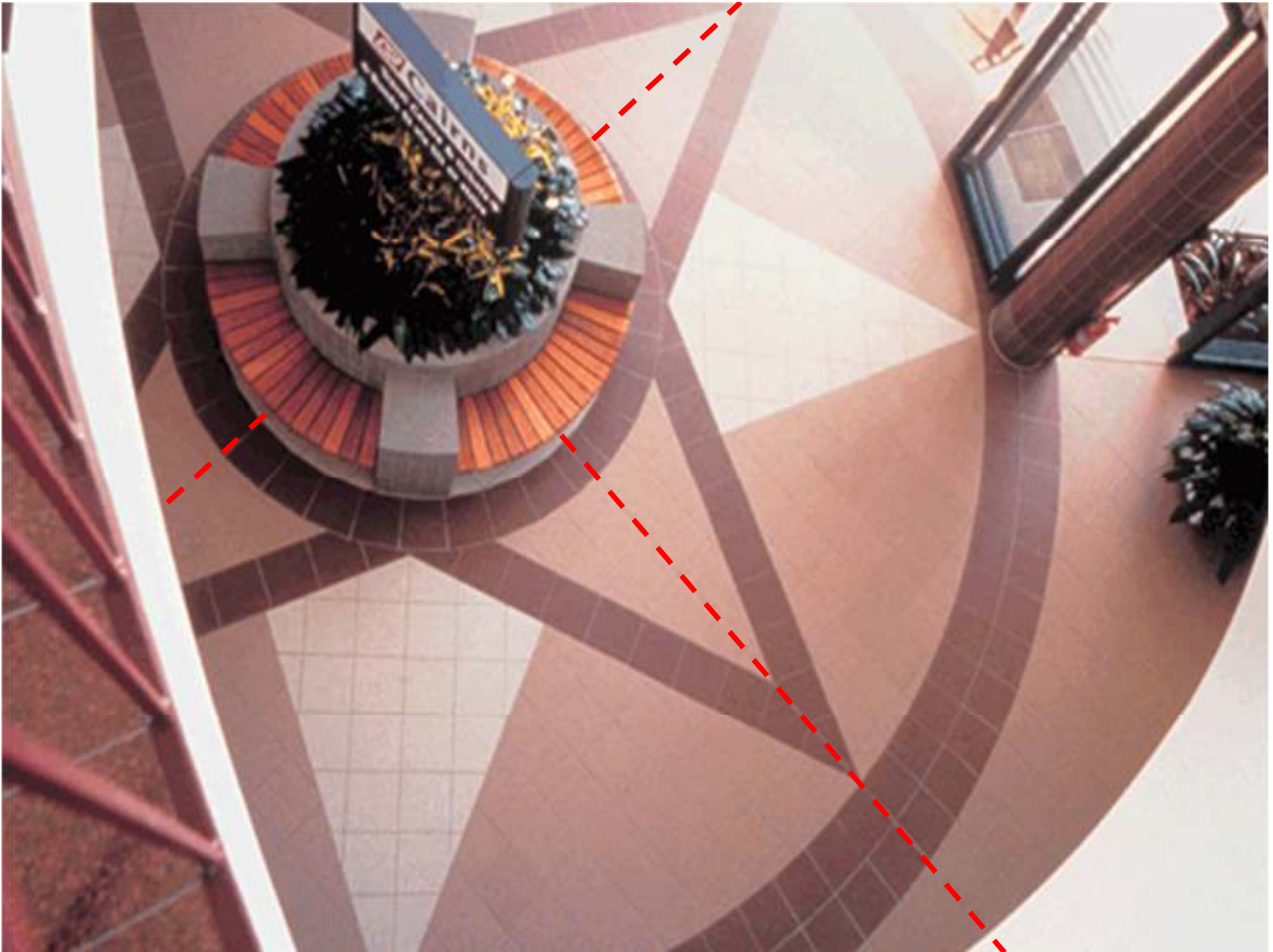



I giunti?

**Dovete tagliare le piastrelle
sacrificando il disegno**



Ecco l'esempio reale del giunto



Con Schlüter®-DITRA 25



.....il giunto si nasconde.

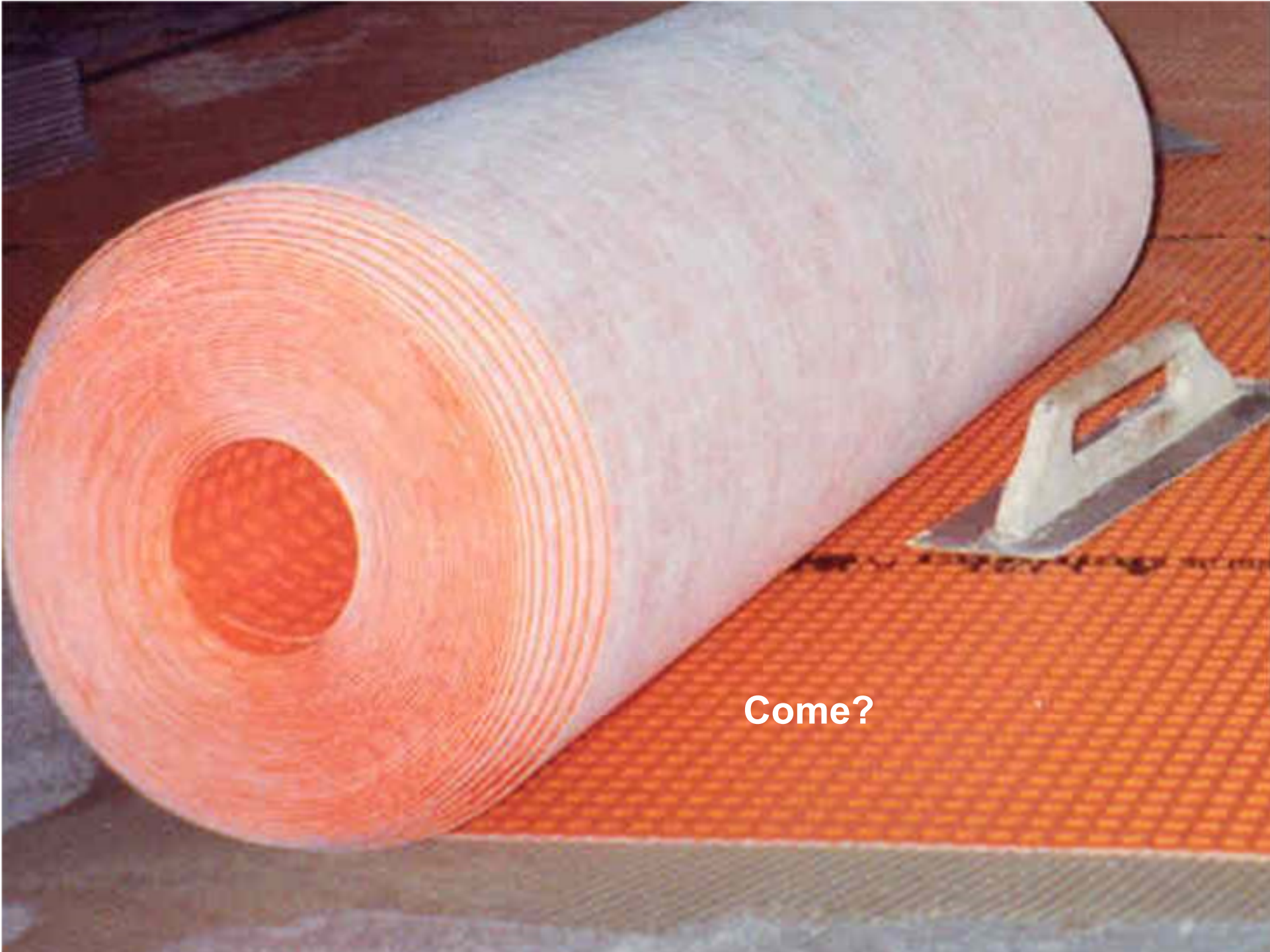

Come?







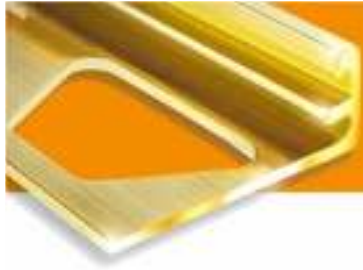

Schlüter[®]-DITRA 25 in separazione

Non solo per estetica ma anche
per risparmiare tempo e denaro

AEROPORTO

BOLOGNA

23  26 APRILE 2013

23 APRILE 2013



26 APRILE 2013



23 APRILE 2013



26 APRILE 2013



23 APRILE 2013



26 APRILE 2013



































Schlüter-Systems

A photograph of a long, straight road with a yellow drainage system in the center, leading towards a mountain range under a clear blue sky. The road is flanked by yellow fields.

www.schlueter.it

Cristiano Ferrarini